



User Manual

For the iQuote Pro platform use

Summary

- 1. IQUOTEWIN6
 - 1.1 STARTUP AND LOGIN6
 - 1.1.1 Settings.....7
 - 1.1.2 Refresh Workgroup.....7
 - 1.1.3 Hide prices.....7
 - 1.2 INTERFACE8
 - 1.2.1 Grid Management9
 - 1.2.2 Columns Layout.....11
 - 1.2.3 Search offers feature12
 - 1.2.4 Advanced offer search and library search for technical data13
 - 1.2.5 Tool Palette Management13
 - 1.3 OFFERS MANAGEMENT (DASHBOARD).....14
 - 1.3.1 New offer14
 - 1.3.2 Save15
 - 1.3.3 Cancel.....15
 - 1.3.4 Open.....16
 - 1.3.5 Duplicate16
 - 1.3.6 Delete.....16
 - 1.3.7 Reload Grid.....16
 - 1.3.8 Quote status management16
 - 1.3.9 Offer versions.....17
 - 1.3.10 Revision17
 - 1.3.11 Offers visibility.....17
 - 1.3.12 Offer templates18
 - 1.3.13 Offer Export18
 - 1.3.14 Offer Import18
 - 1.3.15 Import from other platforms19
 - 1.3.16 Offers paging19
 - 1.3.17 Offers grid layout.....19
 - 1.3.18 Offer statistics20
 - 1.3.19 Print Offer.....20
 - 1.4 OFFER DETAILS20
 - 1.4.1 Main20
 - 1.4.2 Customer.....21

1.4.3	Price List	22
1.4.4	Conditions	23
1.4.5	Additional Costs	23
1.4.6	Attachments.....	23
1.4.7	Areas	24
1.4.8	Other Properties	24
1.4.9	Security.....	25
1.5	OFFER.....	26
1.5.1	Library	27
1.5.2	Library - Searches.....	28
1.5.3	Library – Item details	29
1.5.4	Library – Inserting items	29
1.5.5	Inserting items by Code	30
1.5.6	Other types of row insertion.....	31
1.5.7	Favorites.....	32
1.5.8	Sorting and numbering rows.....	32
1.5.9	Editing offer rows.....	34
1.5.10	Descriptions management in personal language.....	35
1.5.11	Surcharges, discounts, and calculation methods.....	35
1.5.12	Cut/Copy/Paste/Delete Rows	36
1.5.13	Item replacement.....	37
1.5.14	Offer Utility.....	37
1.5.15	Synchronize data	39
1.5.16	Item list.....	39
1.5.17	Export List.....	39
1.5.18	Connection Configuration	40
1.6	PRINTS	40
1.6.1	Print offer	40
1.6.2	iQuote Print Settings.....	40
1.6.3	Print Export	42
1.6.4	Storage of the offer in PDF as an attachment	42
1.6.5	Print sales analysis	42
1.6.6	Print catalogue	43
1.6.7	Autogenerate equipment data sheet	45
1.7	CUSTOMERS /SUPPLIERS ACCOUNT.....	46
1.8	CUSTOM LIBRARY	46

1.8.1	Creation of calculated price lists.....	48
1.9	IQUOTEWIN OPTIONS	49
1.10	SERVICE MESSAGING	52
2	IQUOTECAD.....	53
2.1	CREATE CAD PROJECT FILE	53
2.1.1	Drawing templates.....	53
2.1.2	Multi-DWG creation.....	54
2.1.3	File DWG opening	55
2.2	INTERFACE.....	55
2.3	AEC COMMANDS.....	56
2.3.1	Walls.....	56
2.3.2	Doors.....	59
2.3.3	Windows	60
2.3.4	Miscellaneous	61
2.4	LIBRARY	62
2.5	OFFER.....	62
2.5.1	Item replacement.....	64
2.6	INSERTING CAD ITEMS	64
2.6.1	Interaction with AutoCAD commands	66
2.7	EDIT ITEM	67
2.8	AREA MANAGEMENT	68
2.9	CONTEXT MENU UTILITY	68
2.10	SPECIAL OR CUSTOM ITEMS	68
2.11	ITEM NUMBERING	69
2.11.1	Utility.....	70
2.12	CONFIGURATORS.....	71
2.12.1	Shelves.....	71
2.12.2	Hoods.....	72
2.12.3	Floor grates.....	72
2.12.4	Cold rooms	73
2.13	FAVORITES	74
2.14	CONNECTIONS SETTING.....	75
2.14.1	Management of customized connection symbols	77
2.15	ITEM LIST.....	78
2.15.1	Add/Edit Template	79
2.15.2	Items list activation	80

2.15.3	Synthetic item list.....	81
2.16	SECTION VIEW.....	82
2.17	GROUP SELECTION ON/OFF.....	82
2.18	LAYOUT	83
2.18.1	Views	83
2.18.2	Annotations	84
2.18.3	Lights	85
2.18.4	Squaring.....	86
2.19	OPTIONS.....	87
3	IQUOTEREVIT	90
3.1	CREATE REVIT PROJECT FILE.....	90
3.1.1	Drawing templates.....	90
3.1.2	Multi-RVT creation	91
3.1.3	File RVT opening.....	92
3.2	INTERFACE	92
3.3	LIBRARY	93
3.4	OFFER.....	93
3.4.1	Item replacement.....	95
3.5	INSERTING REVIT ITEMS	96
3.5.1	Interaction with Revit commands of iQuoteRevit	97
3.6	EDIT ITEM	97
3.7	AREA MANAGEMENT	97
3.8	SPECIAL OR CUSTOM ITEMS.....	98
3.9	ITEM NUMBERING.....	98
3.9.1	Utility.....	99
3.10	CONFIGURATORS	100
3.10.1	Shelves.....	100
3.11	CONNECTIONS SETTING.....	101
3.12	ITEMS LIST.....	102
3.12.1	Add/Edit template	103
3.12.2	Items list activation	104
3.13	OPTIONS.....	105
4	IQUOTE BACKOFFICE	107
4.1	IQUOTE MANAGEMENT SERVER.....	107
4.1.1	Statistics	108
4.1.2	Permissions (Users, Roles, Workgroups)	108

4.1.3	Property	109
4.1.4	Property - Connections symbols	110
4.1.5	Settings - Currencies	110
4.1.6	Settings – Sizes, Units of Measure	110
4.1.7	Settings - Unit of Measure Configuration	110
4.1.8	Settings – Conditions	111
4.1.9	Settings – General Options	112
4.1.10	Settings – Languages Management	114
4.1.11	Settings – Proxy Options	115
4.1.12	Settings – Mail Settings	115
4.1.13	Settings – iQuote Account	115
4.1.14	Settings – FTP Account	115
4.1.15	Setting – Jobs.....	115
4.2	DIM	116
4.2.1	Biographical Data	116
4.2.2	Licenses	116
4.2.3	Brand	116
4.2.4	Ticket.....	117
4.2.5	DIM users	117
5	IQUOTE LIVEUPDATE	118
5.1	IQUOTE LIVEUPDATE	118
5.2	INTERFACE	119
5.3	UPDATE WIN/CAD/BACKOFFICE/BRAND	120
5.4	UPDATE FILE	121
5.5	OPTIONS	121

1. IQUOTEWIN

1.1 STARTUP AND LOGIN

When iQuoteWin starts, first thing to do is to log in. You must therefore be in possession of the credentials (of the own software, independent of Windows credentials or corporate domain).

For information about credentials, look at the administration panel section, or contact your network administrator.

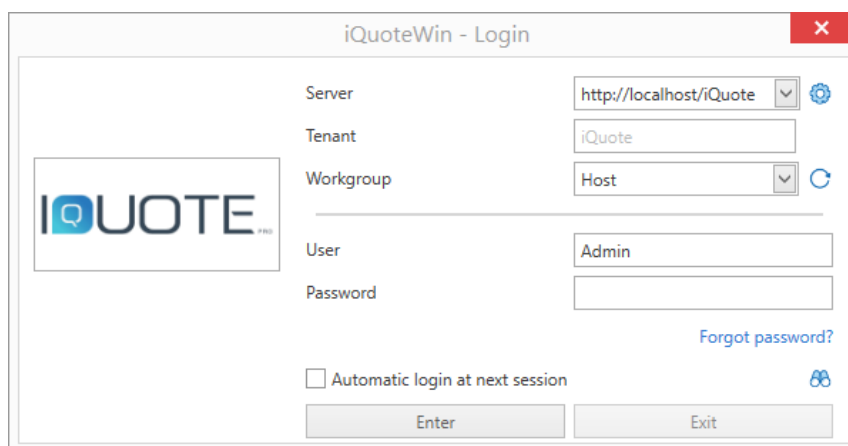

- **Server:** iQuote allows you to connect to a server geolocated anywhere (on your local computer, on a LAN computer or server, or on a remote computer/server). Enter here the installation address (communicated by your network administrator) to connect to.
- **Tenant:** the field, set by default with the value "iQuote", is used for the connection to the iQuoteCloud server.
- **Workgroup:** this field is not editable, workgroups found in the installation indicated in the "server" field are automatically proposed. Select your workgroup, which is part of the login credentials communicated by your administrator. For more information about workgroups, look at relative section.
- **User:** enter your username (first time you start default user is: **admin**).

- **Password:** enter the password associated with your username (first time you start default password is: **password**).
- **Automatic login to the next session:** Check this box to store the entered data and then log in automatically at startup. You will be able to change your login data at any time by logging out.

1.1.1 Settings

If you are connecting to a remote installation through a proxy server, enter the proxy server data (contact your network administrator if you do not have such data).

Software is able to store at the user level a number of settings regarding user interface, so you can have the same settings even if you were to log in on other PCs. To delete these settings and return your user to default settings, you can check the reset entries for all or some categories.

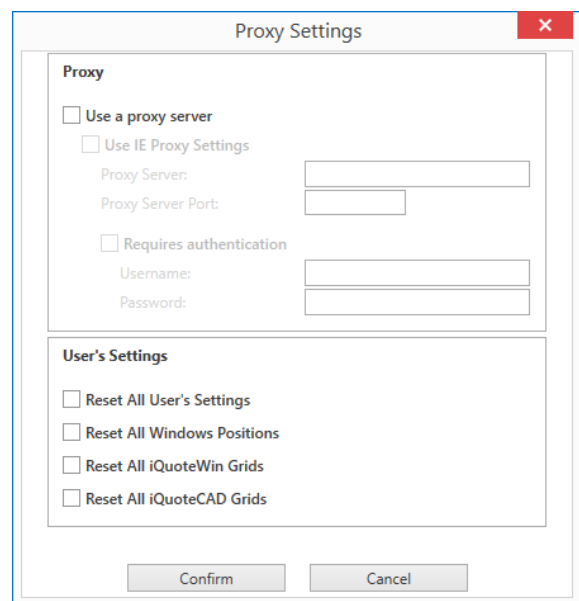

1.1.2 Refresh Workgroup

Pressing this button, the list of available workgroups on the selected server will update.

1.1.3 Hide prices

You can start software hiding sales/cost prices from any screen. For example, if you are using software together with people, who do not have the right to see such information.

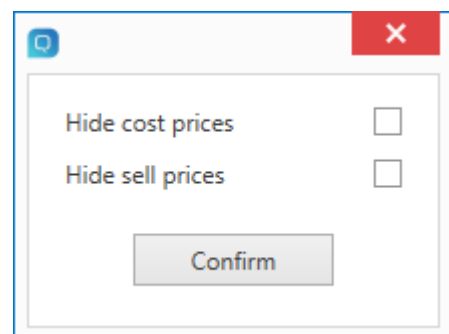

1.2 INTERFACE

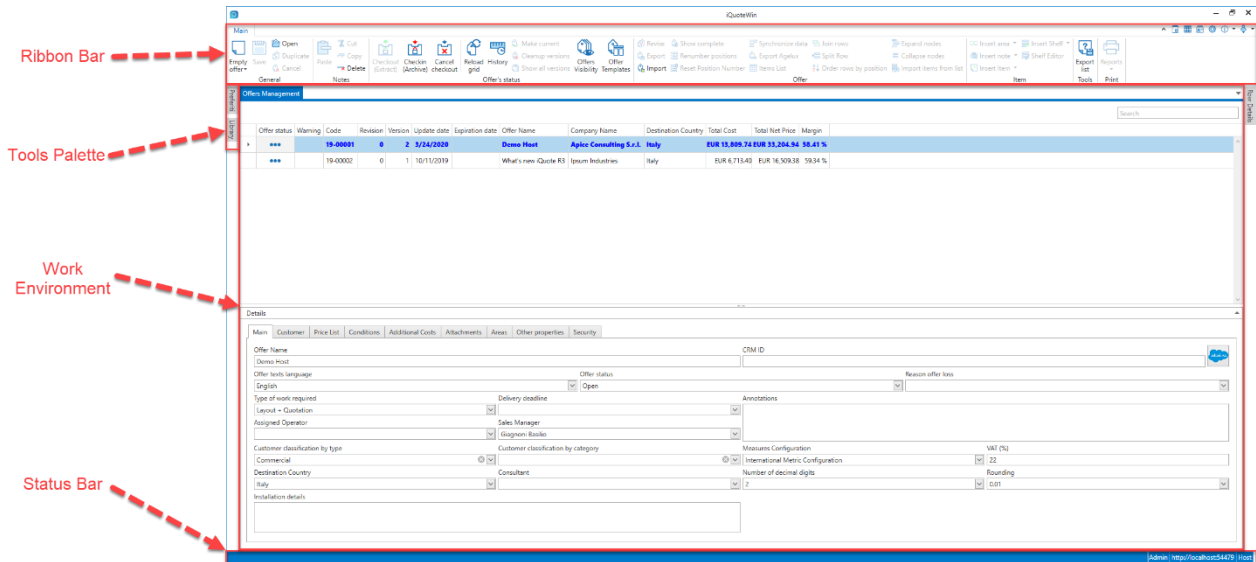

Software interface is designed to allow a quick approach to the use of the program.

Ribbon shows only commands you can use in the current work environment.

Tool palettes (library, favorites, edit line) can be set to the sides of the work environment or fixed open at all time. You can also undock them from the work environment to move them to additional screens.

Work environments (quotation management, quotations, account, library management, options) appear as individual windows docked in the central area. You can open multiple work environments at the same time, such as 2 quotations. At any time, you can place side by side or undock these windows to move them to additional screens.

To undock a palette or work environment, simply press the title of the item you want to undock and drag. Anchor points will appear where eventually to fix, or it can be released free to any point of the screen.

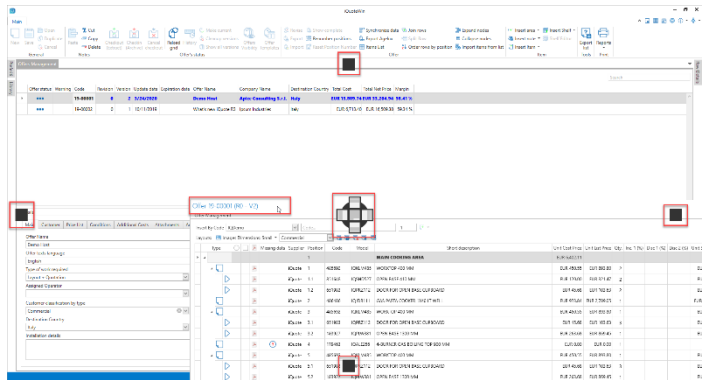



At the top right of the iQuoteWin window there is a series of buttons allowing you to open some specific work environments. From left to right, you can then:

- Enter the administration site (look at 4.1)
- Manage your personal libraries (look at paragraph 1.8)
- Manage customer/supplier account (look at paragraph 1.7)
- Manage client program options (look at paragraph 1.9)
- Miscellaneous Utilities

From this menu, you can access information about your version, the display of system logs, and other system utilities.

- User management

From this menu you can log out of the system or change the password of the active user.

1.2.1 Grid Management

Column view management is the same in dashboard (quotation list grid) and in the editing of quotations. Setting of columns is very elastic and customizable, this allows a layout of the workspace highly adaptable to individual needs, as well as offering quick and intuitive filters.

Offer status	Code	Revision	Expiration date	Description	Company Name	Destination Country	Language
--------------	------	----------	-----------------	-------------	--------------	---------------------	----------

By placing cursor over the column header, you can:

- Click with the mouse to sort according to that column.
- Hovering over the column header, quick filter icon appears next to the name: clicking it a drop down with the row values appears. Clicking on the value of interest all rows containing that value in that field



- Right-clicking anywhere in the header row displays, menu to customize and set the grid view appears.

The first three entries allow you to work on sorting columns, considering that:

- With any sorting enabled, this prevails on every automatic sorting. Moreover, it will also be restored on next iQuoteWin opening.
- Without any sorting enabled, iQuoteWin will automatically put at the top the offers in checkout (offers' status will be explained at paragraph 1.3.8), sorting them by last edit date (descending).
- To delete an active sorting, right click on the column which have sorting enabled and select "Clear sorting".

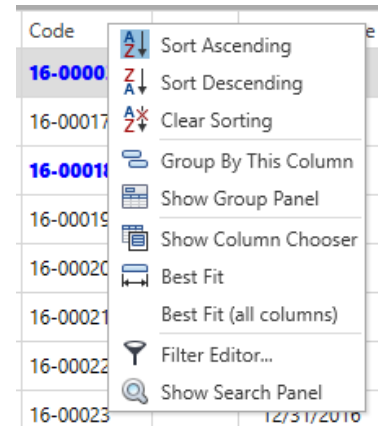

"Group by this column" changes the grid view, showing the list of projects (or quotation rows) grouped by that field.

"Show Group Panel" is closely related to previous command: selecting it, fields for which a grouping has been done appear above the grid, allowing (in case there are multiple fields) to manage sort order by field too.

Right-clicking then on the grouped column, there are the various options described here and in addition the choice "Ungroup", to disable that specific grouping and then return to the view of the classic grid, as in the image on the right.

"Show Column Chooser" opens the list of all viewable columns in the grid: you can freely insert or remove columns you want to use, thus customizing your own grid.

"Best Fit" or "Best Fit (All Columns)" automatically adjusts the width of the individual column or all columns in the grid.

"Filter Editor" allows you to create a totally free filter on the grid, choosing what to display between one or more fields and one or more values.

"Show Search Panel" opens a text box above the grid to perform a free search in the displayed grid: enter the search term and press "Enter".

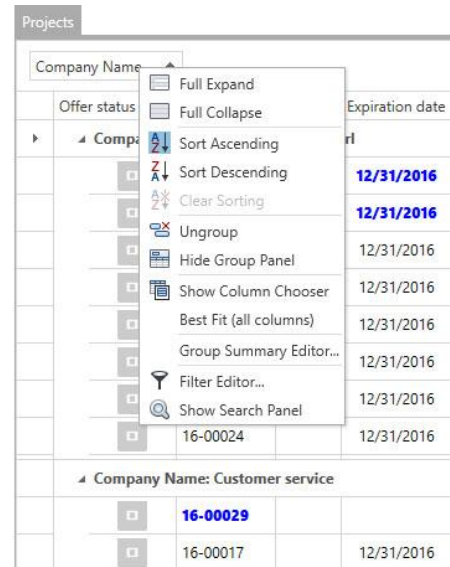

In the "Offer" work environment, you can store different grid configurations and recall them at will (look next paragraph 1.2.2)

N.B. Structure you choose for grid views is stored in the database for each individual user. This means that by logging into iQuoteWin from another installation (or after reinstalling/reinstalling the client), settings set by a specific user are automatically loaded.

1.2.2 Columns Layout

Formatting of columns in the offer grids can be customized as desired using the dedicated button above the grid:



This button allows you to access the cell formatting management tool, enabling the creation of rules based on cell values. This functionality is very similar to conditional formatting in Microsoft Excel. In addition to creating formatting rules from scratch, you can access the quick conditional formatting menu and select one of the rules suggested by the software based on the type of data in the column. To do this, simply right-click on the column you want to format, navigate to the "Conditional Formatting" option, and select the desired formatting rule. Later, by right-clicking again, you can clear the formatting or activate filters.

Offer status	War...	Code	Update date	Offer Na
...		FAB24-00003		
...		FAB24-00002		
...		FAB24-00001		
...		APC23-00003		
...		APC23-00002		
...		APC23-00001		
...		23-00250		
...		23-00249		

The conditional formatting and grid view settings described earlier can be saved in different configurations (called layouts), allowing you to switch between multiple grid display solutions. You can use the same conditional formatting toolbar above the grid to save and manage these configuration layouts, which can then be quickly retrieved from the dropdown menu in the toolbar.

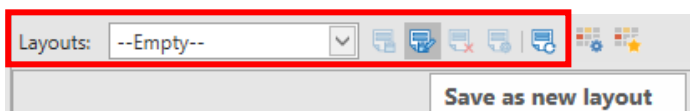

When saving a new layout, you can define its visibility. This choice determines whether other users working on the same the saved layouts. This standalone installations. the following modes:

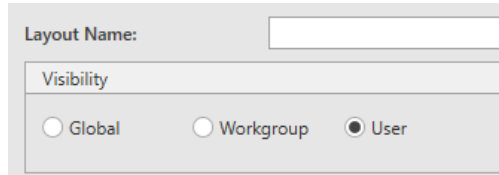

iQuote Pro database can use selection is irrelevant in Layouts can be made visible in

- Global: Available to all users working on the database
- Workgroup: Available to all users within the same workgroup
- User: Available only to the current user

1.2.3 Search offers feature

In the search box at top-right it is possible to search through the offers. The search run through all columns enabled into the grid view, so, it is possible to type, for example, part of offer code or offer title or customer name etc.

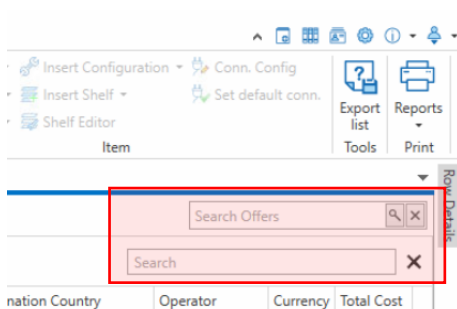
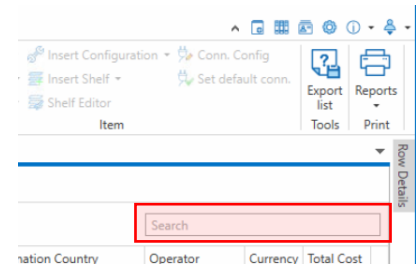

NB. When “Dashboard Page Dimension” (explained into paragraph 4.1.8) is set, iQuoteWin could load two search boxes like in the picture: it is recommended to close the second one clicking on “X” using the first one. In fact, second one will make research only through the offers loaded into the current page(s) while the first search box will run research through all existing offers, in the hidden ones too.

1.2.4 Advanced offer search and library search for technical data

It is possible to carry out advanced searches on the offer list, in order to more easily identify offers that reflect certain criteria. It is possible to filter for all the general fields of the offers and for all the fields of the offer lines, i.e., of the products included in the offer.

For example to search for which offer contains a certain item.

In the item library it is possible to search using information related to connections as a filter.

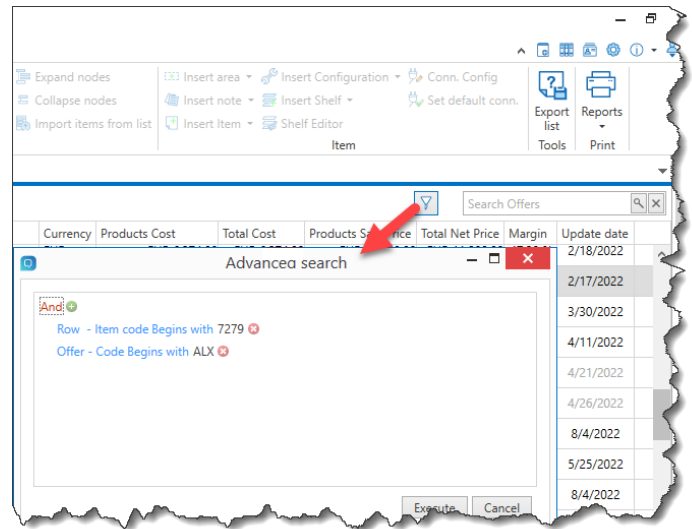

1.2.5 Tool Palette Management

Tool palettes (such as library) are windows that can be tab-clicked or that automatically open and close when mouse is over palette. Otherwise, by using a special icon (), you can always lock them open.

You can also dock them to the sides of the screen or leave them free to, for example, move them to a secondary screen.

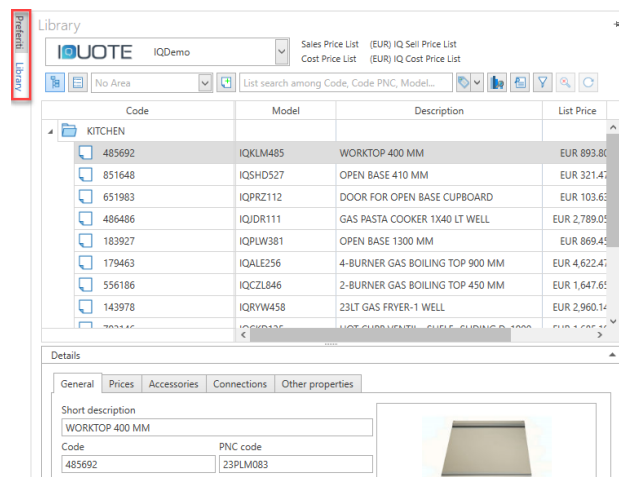

1.3 OFFERS MANAGEMENT (DASHBOARD)

First work environment appearing when the software starts is the offer management. This is the only environment that cannot be closed.

Offers management is divided into two sections:

- First one contains created offers summary.
- Second one contains selected offer details.

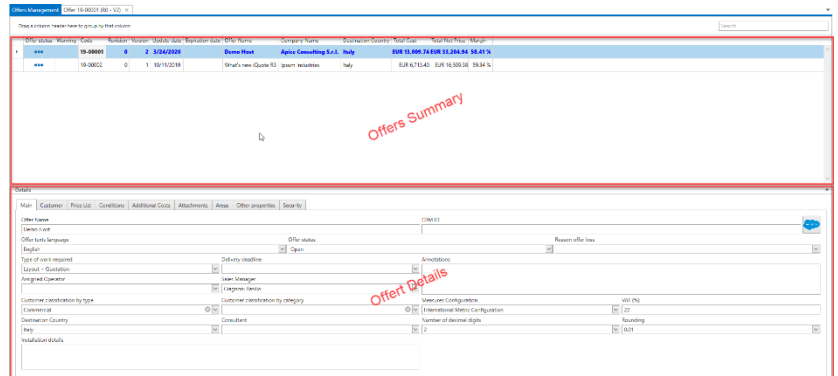

Offers are highlighted and have different fonts and colors depending on the state (explained in paragraph 1.3.8) they are:

bold font, blue color

offers in checkout

normal font, black color

offers in checkin

normal font, gray color

checkout offers from other users

(For more information on checkin and checkout, go to 1.3.8)

1.3.1 New offer

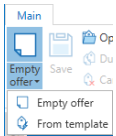

Allows the creation of a new offer (command is active only in the Offer Management).

You can select two different ways to create the quotation:

- **Empty Offer:** Create an empty offer without any kind of setting.
- **From Template:** creating an offer starting from an existing template and then with the possibility of having already preset several settings (for creating a template see paragraph 1.3.12)

Each quotation that will be created will have automatically assigned a code consisting of an alphanumeric prefix of up to 5 characters, followed by a separator dash and a progressive number along 5 positions, automatically generated by the system. For instance, ABCDE-00001.

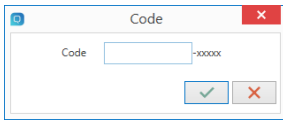

Prefix can be set fixed in the options or it can be variable and therefore required at each offer creation in a special window.

If you choose to create a template offer, a template window will allow you to choose the template to use.

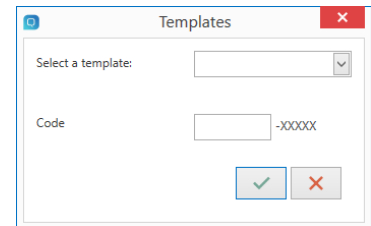

In the section dedicated to the details you can enter all the data of the offer, for the deepening of the details go to paragraph 1.4. When the entry is complete, clicking save will display data in the offer summary row, in the dashboard.

1.3.2 Save

 Command activates automatically when the system detects unsaved changes and is working in all iQuote environments (Project Manager, Edit Quote, Options, ...).

The presence of unsaved changes is also highlighted by the software by changing the color of the status bar, turning red.

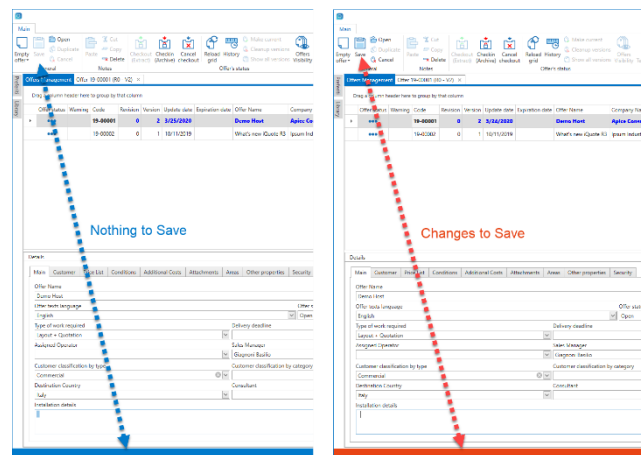

1.3.3 Cancel

 If there is a change to be saved, but you want to undo the change without saving, use the Cancel command that is enabled next to the Save button.

1.3.4 Open

 **Open** The "Open" command opens the selected offer (you can also use the double click or right button above the project line). Offers are opened in new tabs, additional to the offer management tab: this allows you to return to the dashboard at any time (without therefore closing the offer), to edit its header data and open multiple offers at the same time.

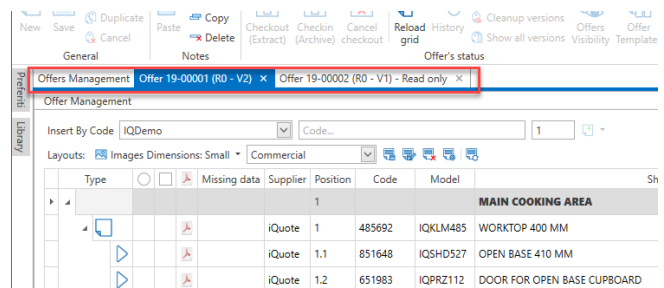

1.3.5 Duplicate

 **Duplicate** The "Duplicate" command duplicates selected object: it can be the main project in the dashboard, an offer line, or a zone of the offer.



1.3.6 Delete

 **Delete** Deletes selected offer (only on checkout offers).

1.3.7 Reload Grid

 **Reload grid** "Reload Grid" is active in both dashboards and on offer. Reloads the offer list view (in case it is in dashboard) or the main view of the zones/items (in case it's on offer). When opening concurrently quotation and DWG drawing, it should be used whenever you switch from drawing to quotation to update quotation view, according to the changes made in the drawing.

1.3.8 Quote status management





   This command group, active only in the dashboard, introduces a new concept of saving and managing projects.

The basic principle is that a project in a "Checkout" state, then "Extract", is editable; a project in "Checkin" state is archived and in read-only status. This system allows a kind of fictitious save/review of the phases of the projects (identified as "versions"): by checking in the project, you go to save

(Archive) a copy at that precise time (without revision or the project itself being duplicated), a copy that will be callable from the history.

The "Cancel checkout" button cancels checkout you have just done.

1.3.9 Offer versions

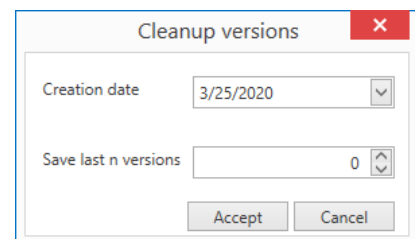

 Make current
  Cleanup versions
  Show all versions
 "History" allows you to access the history of the selected offer: all revisions made of the project are shown by default. Clicking "**Show all versions**" you can also view all checked-in done (displayed in gray). To restore the project status to a specific previous revision/checkin, select it and click "**Make Current**".

Using "**Cleanup Versions**" command, you can delete some versions you no longer need. A window appears allowing you to delete old versions older than a certain date, or you can choose to keep only a certain number of versions. In any case, versions only are deleted (checkin) and revisions are not deleted under any circumstances.





Clicking "Reload Grid" exits the "History" view, returning to the project list.



1.3.10 Revision

 Revise Reviews the selected offer (revisions that can be viewed and are recoverable from history): a (hidden) copy of selected project is created by assigning a progressive revision number (first revision will be marked with " revision 1", second with "revision 2", etc.).

1.3.11 Offers visibility

When the offers store starts to become heavy, you may need to hide older offers in order to lighten the amount of data that needs to be loaded when software starts. This will not physically erase offers, but they will simply be hidden. You can restore their state at any time.

 Pressing this button offer grid changes display type and shows all offers in the archive (including any hidden ones), an additional column () and  a new toolbar are shown.

You can  then  Search Offers select an offer or a set of offers directly in the grid, and right-click select "**Hide**" to archive selected offers or "**Show**" to restore the display of previously hidden offers.

Optionally, you can use the toolbar to automatically hide all offers before a certain date. When you've done, pressing again the "Offers Visibility" button, only not hidden offers are loaded.

1.3.12 Offer templates

To avoid having to set up common details each time you create a new quotation, you can create one or more templates to use when creating new quotations, so that you have already set up various information such as, for example, price lists, discount/increase, sales terms, ...

To create a template, simply create a new offer and set the information you want to include in the template, then right-click the offer and select "Save as Template" and give it a name.



Pressing this button will allow you to display the list of templates you have created and optionally edit them, as if they were normal offers (press the button again to return to normal view).

1.3.13 Offer Export

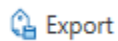

"Export" exports project to an ".iql" file, that can only be imported from iQuoteWin, the same installation or another. You can choose whether or not to export cost list and/or attachments; you can also protect the .iql file with a password. You are asked a place to save the file: when the export is complete, the .iql file will contain everything related to the project, so both the quotation lines and (if the "Export Attachments" option are selected) also the drawing file DWG.

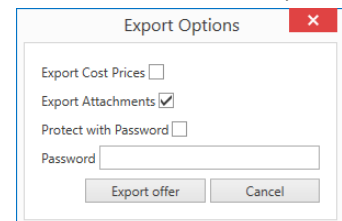
A screenshot of the "Export Options" dialog box. It contains four checkboxes: "Export Cost Prices" (unchecked), "Export Attachments" (checked), "Protect with Password" (unchecked), and a "Password" text field. At the bottom, there are two buttons: "Export offer" and "Cancel".

Files relating to items made at the moment and to custom libraries will also be contained, so as to provide those who import offer with any visual and graphic information that may be missing.

1.3.14 Offer Import



"Import" imports the ".iql" files, generated according to the specifications listed in the previous step "Export". If the .iql file has been password protected, you must have the password of the creator of the .iql file. After the import to iQuoteWin is finished, the .iql file can be deleted. You can choose whether to import the offer with the original name or with a new name (a new progressive code is then assigned). In case you choose to keep the original name and an offer with the same name already exists in the archive, it is imported as a new version and then replace the one existing (which will still be viewable using History).

When importing the offer, the presence of the files relating to the items made at the moment and from custom library is also verified: if not present, they are placed in the specific folders.

1.3.15 Import from other platforms

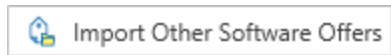

It is possible, within iQuoteWin, to import offers from other sources. By selecting the "Import Other Software Offers" item from the drop-down menu on the "Import" button, you can proceed to import offers from non-iQuote sources.

After an initial analysis of the file, user is asked, if any, to associate the types of sales conditions with those present in iQuote; the program provides a first mapping, in order to facilitate the operation for the user.

All attachments associated with the offer, including projects, are inserted as simple attachments.

1.3.16 Offers paging

In order to speed up iQuoteWin loading, it is possible to load offer pages. To activate this option you need to go to the administration site and indicate the number of offer you want to load (see point **Error! Reference source not found.**).

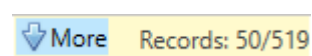

To load additional offers, simply click on the "More" button in the bar at the bottom of the grid.

The searches and the ordering of the offers will take place, however, on all the offer that will then be loaded based on the number of offers per page selected.

1.3.17 Offers grid layout

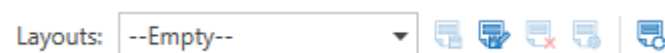

As for the "offer" view (see point 1.2.2), you can save custom columns layouts. It is therefore possible to save, and later select, a configuration that can meet the operator's needs when using the application.

1.3.18 Offer statistics

To facilitate the analysis of the use of the offers, a view has been added that allows you to consult some statistics related to the selected offer: subdivision of total sales for the various suppliers, as well as for the margin and processing times on a specific version.



The view can be opened from the context menu (right mouse button) or by pressing the appropriate command in the ribbon bar.

It is also possible to view statistics relating to several offers: it is, in fact, possible to launch the command after selecting several offers or, after having grouped them (see point 1.2.1), the header of the desired group.

1.3.19 Print Offer

You can launch iQuote printouts even without accessing selected offer using the appropriate command in the ribbon. For customizations look at point 1.6



1.4 OFFER DETAILS

By selecting an offer from the offer list, you can enter its characteristics at the bottom of the screen. On video you can look at several tabs, that identify various categories of information we can fill in for selected offer.

1.4.1 Main

In the first "Main" tab, we can find the possibility to indicate different general information that can be useful to classify the offer. Some of this information can be selected from the drop-down or entered manually. Look at paragraph 0.

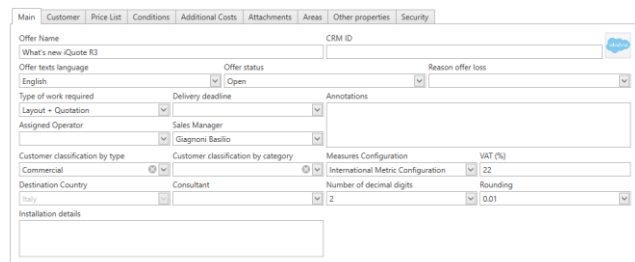



Note that within this tab is also the selection of the offer language, that's the language in which product information and print labels are displayed.

1.4.2 Customer

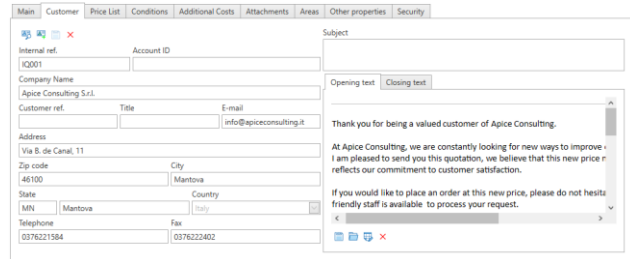
On the "Customer" tab, you can enter customer data, opening and closing quotation text and the subject of the offer.



 Through this toolbar you are able to manage customer's information. Using the first icon you can collect customer's information from a previously stored customer account (look at paragraph 1.7. Second button allows to disconnect customer's information taken from the account and make them independent, this means that the information can be changed. In case customer's information are entered manually, third button will allow you to store that customer master data information for future use. Fourth button allows the emptying of information related to the customer.

 In the opening and closing text area is another toolbar allowing you to edit, store or upload opening texts from a shared archive. Using first icon you can store opening/closing text as a name, you can also choose whether stored text will be private (only the current user can use it) or public (all users who connect to the same archive are able to use it). Second icon allows you to recall the management window of previously stored Open/Close texts, from where you can make them active, delete, rename, duplicate, edit.

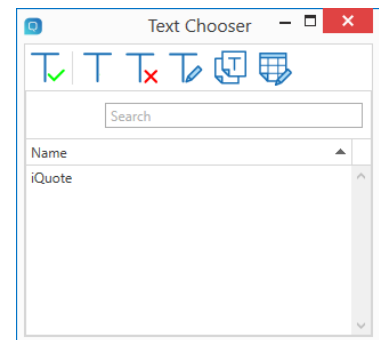

If you use the open/close text editing command, you can see a text editing allowing advanced text formatting with the ability to insert images as well (such as a signature or company logo).

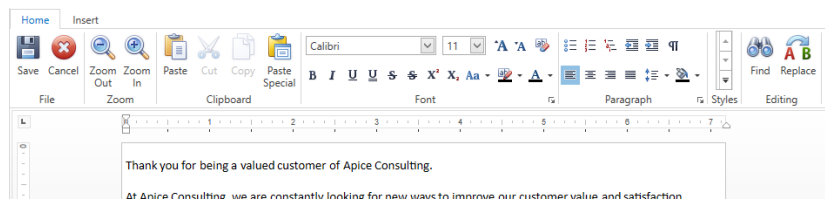

1.4.3 Price List

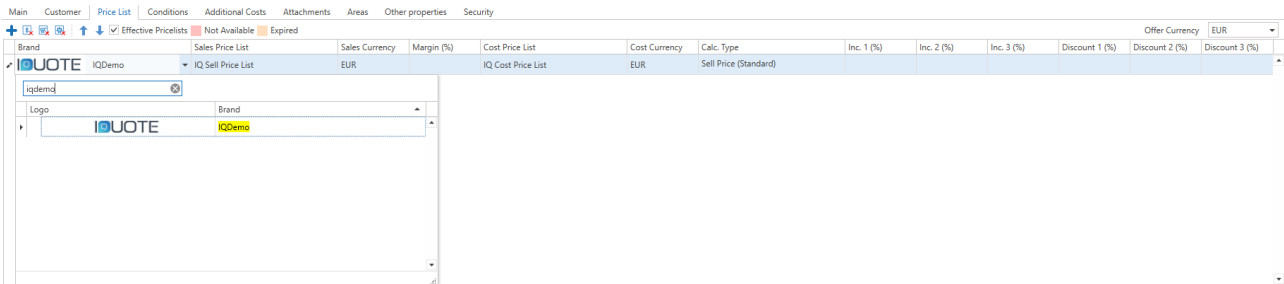

Each manufacturer within the iQuote platform, in addition to its own item library, provides one or more sales/cost lists concurring to compose the list of items that will be included in offer from the library. Price lists can contain sales or cost prices or, for Zero price lists, have the only function of enabling items in the library, but all prices will be valued at zero.

Price lists, and therefore the available trademarks, depend on the permissions received. In practice, a request to the manufacturer must be made in order to be enabled for the use of the data (look at paragraph 4.2.3). Each price list has an effective date and a currency, you can also view expired price lists by pressing on the “Effective” check box. Choosing at least one price list is required to be able to browse library during the creation of the offer.

If you have the permissions, you can also use a cost price, instead of (or in addition to) sales price list. For each price list, both sales and cost, general margin/discount/increase values can also be set up, which are then automatically displayed and set up in library and quotation grid. This is to avoid having to set them up with each item entry (in any case it remains possible to vary them later or to set them differently from time to time during insertions).

Also from this section, you can set currency for current offer: as soon as currency setting is saved, a panel is activated where you must set the exchange rate for the currency you set (you can also set the default exchange rates on the administration panel, look at paragraph 4.1.5). Setting exchange value automatically shows the list value multiplied by the exchange rate in library and quote grid. Currency can also be changed later or at the end of the offer, the values are always automatically recalculated.

You can change the default active price lists or discounts even when you have already entered items on offer. In this case, when you save change to the price lists, a window appears summarizing changes being applied.

Recalculate offer

The lists were edited, choose if apply the new values to items/accessories.

Type	Po...	Description	Code	Model	Supplier	Discou	Use recalcu...
<input checked="" type="checkbox"/>	59	OPEN BASE 800 MM	371113	E7BAN...		Absenti 25	<input checked="" type="checkbox"/>
<input checked="" type="checkbox"/>	59.1	DOOR FOR OPEN BASE CUPBOARD-ZANUSSI	206342	DOORZ		Absenti 25	<input checked="" type="checkbox"/>
<input checked="" type="checkbox"/>	60	4-BURNER GAS BOILING TOP 800 MM	372001	Z7GCG...		Absenti 25	<input checked="" type="checkbox"/>

Select all Deselect all Confirm

In practice, each quotation line shows whether or not there

has been a price or discount change. For discounts and surcharges, you can choose whether or not to accept the change.

1.4.4 Conditions

On the Conditions tab, you can set up the various sales conditions associated with the selected quotation. The different items can be entered manually or taken from the appropriate drop-down menus (look at paragraph 0 to set drop-down lists). There are also 4 conditions that can be fully customized in both value and label.

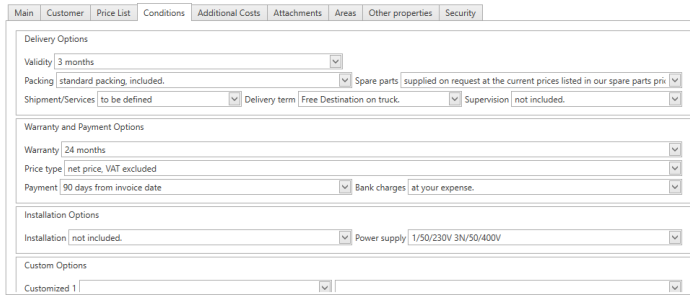

1.4.5 Additional Costs

On the Additional costs tab, you can specify a set of costs, that will be added to the bid total. For each cost, you can specify a description, a sales amount, and a cost amount. Again, you can pick up description from dedicated and customizable drop-down menu.



1.4.6 Attachments

On the Attachments tab, you can store any type of file that may be related to the offer. This also includes, for example, any emails or office documents, so you can easily find them at any time. To do this you need to select first command "New Attachment", then a window is launched, to select the file within the disk or network.

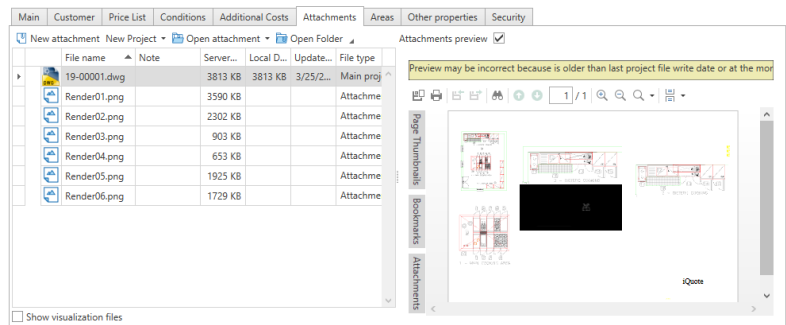

From this window, you can also create Project attachments, for those who use iQuoteCAD too (look at Chapter 2) or iQuoteRevit (look at Chapter **Error! Reference source not found.**). Next to the attachment grid is a preview panel, displaying most common file types.

Attachments, regarding project or not, are stored in a dedicated folder, whose name is chosen by the system. Access to attachments should be made exclusively by iQuoteWin application, avoiding direct access to attachments from operating system. In any case, if you need to access the offer attachments folder, you can use the "Open Folder" command.

You can organize the attachment list into folders and subfolders. This novelty allows you to put order in cases of offers with many attached documents. However, the organization in folders remains a virtual and not a physical arrangement. This means that user visually sees attachments divided into folders, but physically files remain in the offer's work folder: so, attachments with the same name are not allowed, even if arranged in different folders.

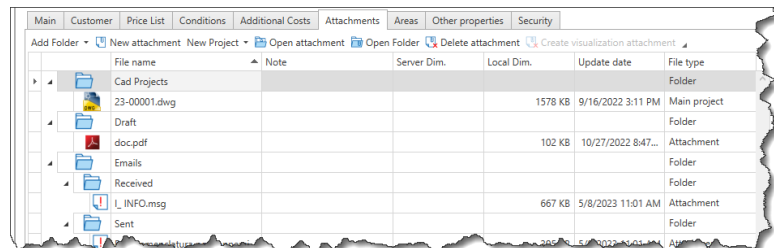

1.4.7 Areas

This section summarizes areas (or zones) in the quotation with their total sales and cost amounts. You can also open a single area by double-clicking, or by using the "Open Area" command and, with the single open area, following the offer printing procedure (paragraph 1.3.19), only the displayed area will be printed.

Position	Description	CAD drawing	Revit drawing	Area Purchase price	Area Total amount	Area Margin
1	MAIN COOKING A...	19-00001.dwg		EUR 6,402.11	EUR 15,636.93	
2	DIETETIC COOKING	19-00001.dwg		EUR 3,004.88	EUR 8,944.89	
3	STORAGE AREA	19-00001.dwg		EUR 4,122.15	EUR 7,775.82	

1.4.8 Other Properties

This section summarizes any additional properties the system administrator has configured for offers. These properties can be compiled according to the rules set when configuring them (look at paragraph 4.1.3).





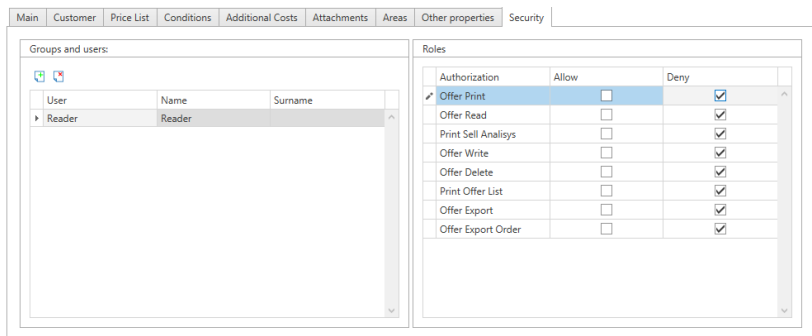

1.4.9 Security

On this tab, you can set the various user rights on selected quotation. In general, user rights are set at the administration level (look at paragraph 4.1.2), however it is always possible from this section to create exceptions in order to change their behavior for specific offers. For instance, you can remove read right or change right on quotations for a particular user.



1.5 OFFER



The "Offer" work environment is activated when we load an offer (see paragraph 1.3.4

Layouts:  Images Dimensions: Small      Grid visible columns can be customized as desired (see paragraph 1.2.1) and different configurations can be stored, so that you can switch grid view between multiple solutions. You can use toolbar above grid to manage different configurations.

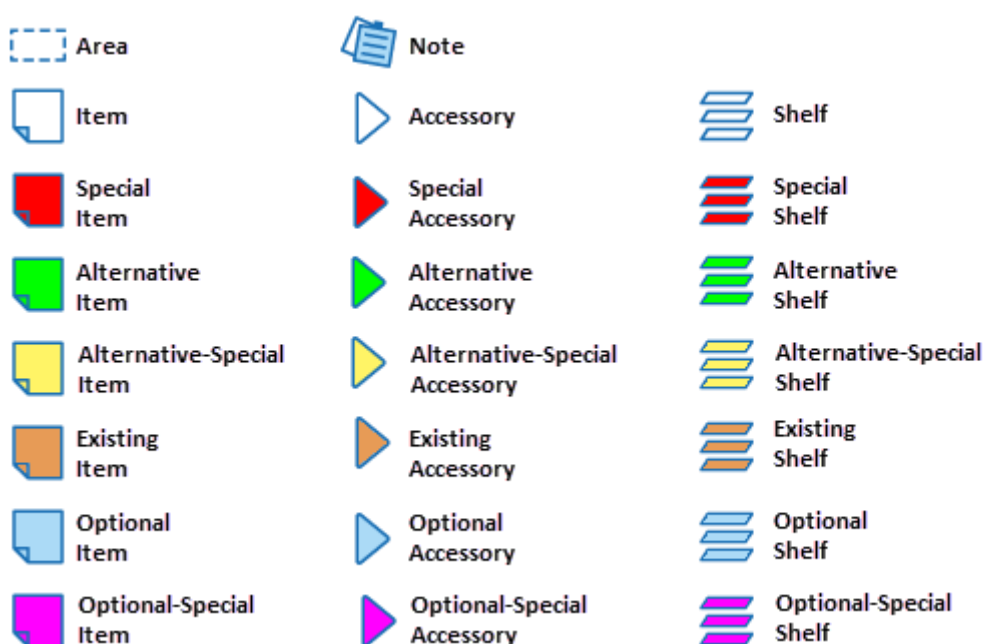
3 palettes (library, favorites, row details) are active too, with tools dedicated to this environment. Within the grid quote lines are displayed. An icon at the beginning of each line identifies the type of line:



Some lines can be displayed with text of different colors or with a square icon of different colors (choice of colors is customizable in the iQuoteWin settings, see paragraph 1.9

-  • Rows not in price list (i.e., items which are out of manufacturer's list)
-  • Rows not in library (i.e., items which are no longer in the manufacturer's library)
-  • Unreferenced rows (i.e., items that do not reference any library)

Some lines may have a different color round icon to identify a possible problem with translating language descriptions:

-  • Short item description may be in a different language than the one selected for the offer

- Long item description may be in a different language than the language selected for the offer
- Short and long item descriptions may be in a different language than the one selected for the offer

On the quotation lines, an icon could appear to highlight () the presence of the datasheet PDF. Pressing on this icon displays full PDF within a browser.

1.5.1 Library

Library is a palette of tools (see paragraph 1.2.5) allowing to consult and insert items within the offer. Brands available within library depend on the price lists selected when setting up current offer (see paragraph 1.4.3).

Palette library is divided into 3 parts: tools, navigation, and details.

In **Tools** we can find choice of brand, search tools and insertion commands.

Navigation is a grid showing the list of items in a tree structure, divided into branches and subbranches. You can enable two different navigation display modes: a tree mode, where items and branches are visible at the same time, and a folder mode, where only active branch is displayed.

 Use this icon to change display from one environment to another.



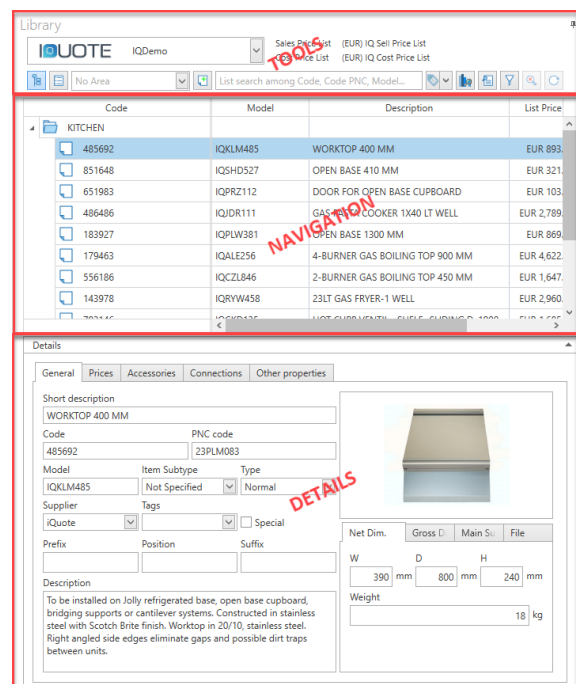

In **Details**, all information about selected item in navigation are displayed.



1.5.2 Library - Searches



Toolbar has a box where you can enter a search text. Pressing Enter after entering text, search starts and the results appear in the Navigation section. By default, searches are only within selected brand and only for Code or Model.

-  Enabling this icon search mode also extends to Descriptions (in addition to Code and Model).
-  Enabling this icon search mode extends the to all active brands for current offer (and not just to current brand).
-  Use this button to cancel a search performed and return to the normal navigation view.
-  Enabling this icon, a filter is applied to results according to certain categories (Tags). Tags are a defined list of categories (oven, kitchen, fire, gas, ...) that some manufacturers have associated to the items so that they can facilitate searches. Next to the icon (which activate/disactivate filter) you can open full list of Tags to activate them.
-  Use this button to open the Advanced Search window, that can produce searches on all item fields. In this window you can search using different types of operators (equal, major, minor, start for, ...) and by making logical combinations (And, Or, Not, ...). Configured searches can be saved for future use.

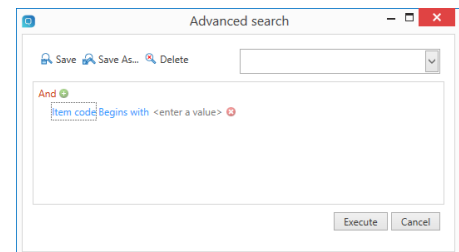

1.5.3 Library – Item details

Navigation grid can be customized as you like (see paragraph 1.2.1) by choosing the number of columns according to your needs.

Leaving mouse positioned over an item line (even if line is not selected) extended description is displayed and, if available, relative picture.

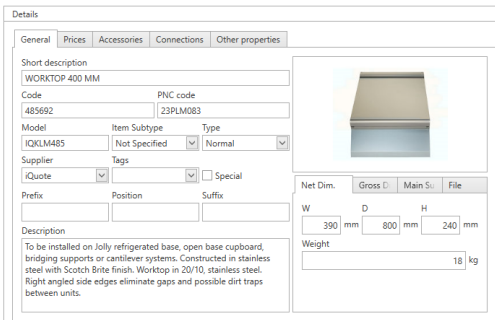

Selecting the row with the mouse involves filling in the underlying detailing fields (if present in manufacturer-supplied database). Note that all tabs except "Connections" tab (so General, Prices, Accessories, Other Properties) can be freely edited for single insertion, that is, any custom values apply only for this insertion and is not stored.

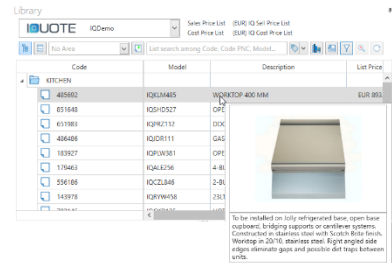

On the Accessories tab, you can see the quantity of accessories included in item in second column (then accessories provided as standard by the manufacturer); in first "quantity" column, you can instead enter quantity of accessories to include in the current entry. You can also insert accessories not listed, by taking them from the library (even from different brands): to do so, you just need to use icon () allowing the opening of a dedicated window.

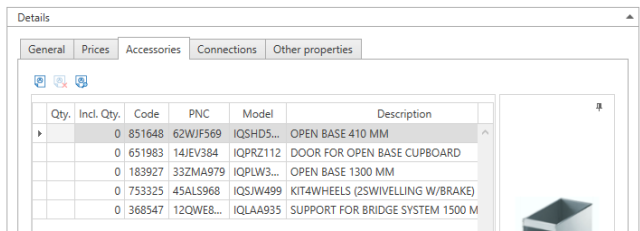

Regarding connections, standard connections indicated by the manufacturer are displayed. You can insert additional connections later, that is editing item once inserted in your offer.

You can save current connection configuration so as to make it available later for the same item or to the automatic insertion of the connection configuration (look at point 2.14).

Finally, in the "Other Properties" tab, you can enter custom properties, which you can manage from the iQuote administration site (look at paragraph 4.1.3).

1.5.4 Library – Inserting items



Inserting can occur for a single row or even by selecting multiple rows from library (using the system multiple selections,  then with

the "CTRL" or "Shift" key). After selecting lines, you can insert item with the "Insert" button by, optionally selecting an area from the drop-down menu next to the button. Items are then placed at the bottom of the area (if selected) or at the bottom of the offer (if no zone is indicated).

Alternatively (much freer and more customizable) there is the drag&drop mode: in fact, dragging items with the mouse from library to the offer you can:

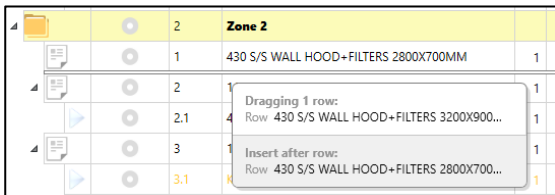

place items in a position you like in the offer by simply dragging them between two existing lines, until separator line becomes as bold as shown in picture. Note how, by inserting item between two accessories, it is automatically inserted as an accessory;

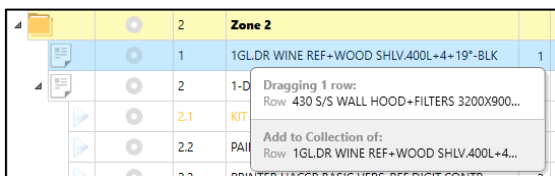

insert items as accessories of an item already inserted, simply by dragging them over the item itself, until the line highlights as in the picture;

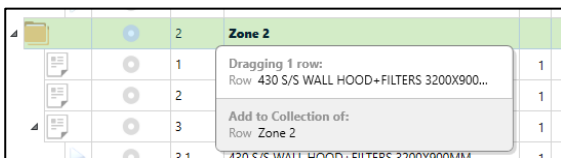

Place items within an existing zone by simply dragging them over the zone itself, until the line highlights as shown in the picture.

1.5.5 Inserting items by Code

If you are familiar with item codes, you may want to insert an item without going through library, simply by knowing code.

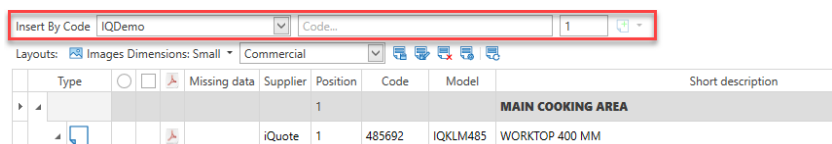

When opening a quotation, a "Insert by Code" bar is visible at the top, above first line: after selecting brand to which item belongs, just type code of the item to insert and press Enter (possibly changing the desired quantity). Item (if it exists in selected brand) is then placed at the bottom of the offer, after last existing line. Cursor remain positioned on the code entry box, so that you can quickly insert a series of codes directly from keyboard.

1.5.6 Other types of row insertion

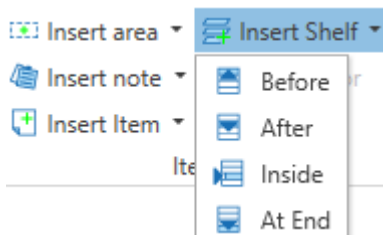

This group of controls allows to insert areas, notes, items and shelves. For each of these commands, after click a drop-down menu appears to choose where to insert line (before, after, inside, at the bottom) compared to the current row selected in the offer grid. In particular, selection of the "Inside" entry means that the inserted row will be the child of the selected row. This mode is not always

available depending on the type of row you selected and the command used.

Insert Area: allows the insertion of Areas within the offer. You can create a tree structure by generating areas with subareas inside. Area is displayed with a different background color and has initially a default name, that can be changed using the row editing commands (see paragraph 1.5.9). Area name can also be taken from a customizable drop-down menu on the administration site (look at paragraph 0).

Insert Item: allows the insertion of a custom item (not present in library). Item being inserted has no built property and can be customized at will. If inserted as a child of another item, it automatically becomes an accessory. By right-clicking an item created with this command, you can optionally copy it to your own custom library, so that you can reuse it in the future.

Insert Note: allows you to insert an annotation line on which you can write text as desired. If entered as a child of an item, note is linked to the parent item. By editing the annotation line, in addition to adding text, it is possible to insert an external document in any part of the offer, in PDF format, which will be displayed in the print preview and, so, printed.

Insert Shelf: allows shelf configurator to start (look at paragraph 2.12.1).

1.5.7 Favorites

"Favorites" tool palette allows to organize a series of configurations frequently used and will speed up the process of items inserting in the offer. A favorite is essentially a group of one or more quotation lines (areas, items, accessories, notes, ...), that is stored with a name and can be placed in offer with a single operation. For example, it may happen that we often put in offer a kitchen with standard configuration (basic, fires, pasta cooker, fryer, oven, ...); we could then save this typical kitchen and put it in the offers without having to insert every single item.

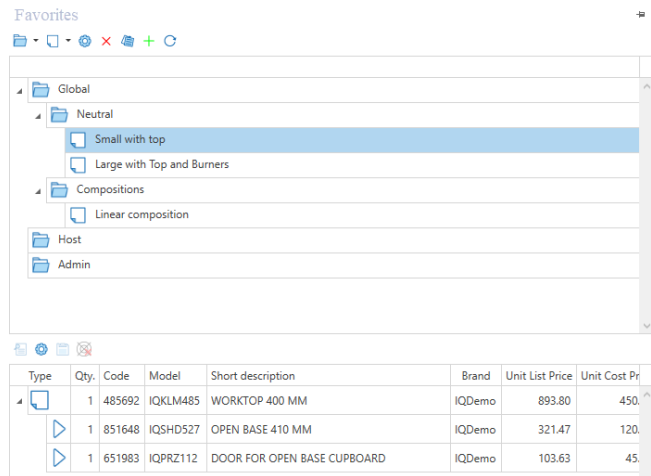

Favorites can be organized into folders, that must belong to one of the three base folders generated by default:

- Global: Global folder visible to all users connected to server
- <Workgroup>: A folder linked to the workgroup you are working in and visible to all users connected to the same workgroup
- <User>: Folder linked to your user and then private

To create a Favorite, after pressing the "New" button and naming it, simply insert items from library as if it were a regular offer.

Note that if used within CAD environment, favorites will also store geometric positioning in space of items (look at paragraph 2.6).

During the insertion phase, user can request the alignment of the favorite's data with those of the database of belonging of the items, enabling the appropriate flag ([Sync Data](#)).

This automatically synchronizes all information to the latest version of the reference library.

1.5.8 Sorting and numbering rows

There are several ways to sort rows:

- By dragging a row of any type (area, article, note, ...) to another location (drag & drop). This allows to sort rows as you like. If you move a row containing child lines (such as an area with items in it), the child lines are moved too.



- Using "Sort by Position" () command, sorting the rows based on their position number, that must have been valued earlier.

 **Renumber positions** By using the Renumber Positions command, you can enable automatic numbering of quotation lines (areas, accessories, items), based on rules established in the interface appearing when command starts. When auto-numbering is enabled, manual editing of item position number is disabled. In practice, numbering is handled automatically by the system. User can still use drag&drop to move lines, that automatically take correct position number.

Automatic numbering can be:

- **By area:** position counter starts from "1" for each area. If, therefore, there are "zone 1" with 3 items and "zone 2" with 5 items, you will get numbering of items in zone 1 from number 1 to number 3; numbering in zone 2 from number 1 to number 5.
- **By area with areaID:** position counter starts from "1" for each area and puts before area number to which item belongs.
- **Continue**– Counter assigns progressive numbering without considering areas. If, therefore, "zone 1" with 3 items and "zone 2" with 5 items are present, numbering of the 8 items is obtained, from number 1 to number 8.
- **Continue with AreaID:** Counter assigns progressive numbering without considering zones and puts before area number to which item belongs.

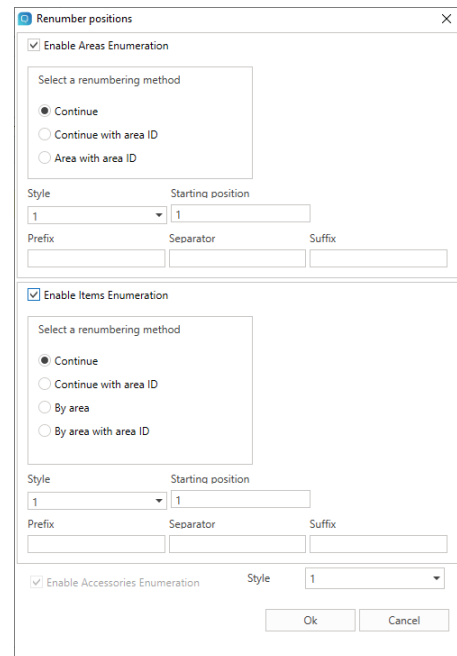

Regardless of which numbering method you choose, you can prefix and/or suffix number, as well as specify a separator to divide prefix/suffix by number. It's possible to set a starting value for the automatic enumeration inserting a numeric value in "Starting Position".

 **Reset Position Number** "Reset Position Number" resets numbering of all lines in the current quotation to "00" (or the default set in the administration site). For the command to be successful, it is mandatory zones and items auto-numbering be previously disabled, using the "Renumber Positions" button. It is not instead mandatory accessories auto-numbering to be disabled.

1.5.9 Editing offer rows

You can edit a row by using two distinct windows, incorporating same functionality, depending on your preference:

- By double-clicking on the line (or from "Open Details" by right-clicking) of an item opens, window containing item data opens. The "previous", "next" buttons move to the following or previous line, to perform same operations.

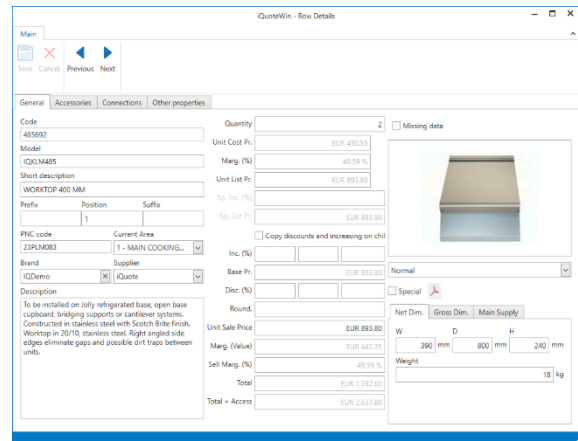

- The "Row Details" tool palette, which is located on the right side of the screen by default and always is showing the information details of selected row in grid. If you select multiple rows in the grid, you can change discounts and surcharges for all selected rows in one step.

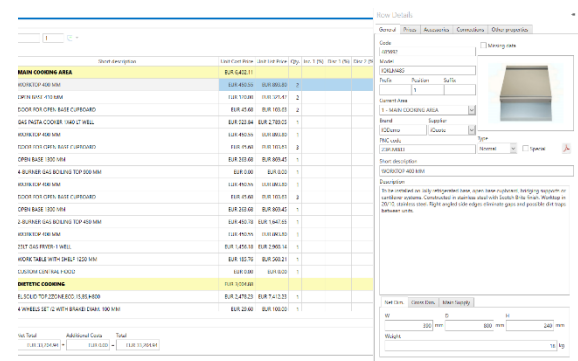

In both modes data are freely editable within the window (in order to change the price list, you must first enable this feature from the administration site). Window shows only relevant data with selected row type (area, note, item).

In the event selected row is a row without a reference to library items, software allows you to customize item by inserting images, data sheets and DWG blocks. Informations are then used the respective environments: images in the print offer, technical sheets in the catalog print and DWG blocks in AutoCAD.

By disconnecting a line from the article, it is also possible to keep the files associated with the article of origin on the new article "on the fly" that has been created.

N.B. These customizations are only available on items without reference to library items.

When you have finished editing data, store via "save" button.

1.5.10 Descriptions management in personal language

User can memorize an alternative description for standard products in the manufacturers' price list. This is an exception to the rule that manufacturers' libraries cannot be modified. The stored alternative descriptions will not be altered by the normal live update process. A short and a full alternative description can be entered for each language offered. This allows the user to make up for any errors/deficiencies in the product description or the lack of a description in the desired language. A particular user right allows the administrator to enable this functionality.

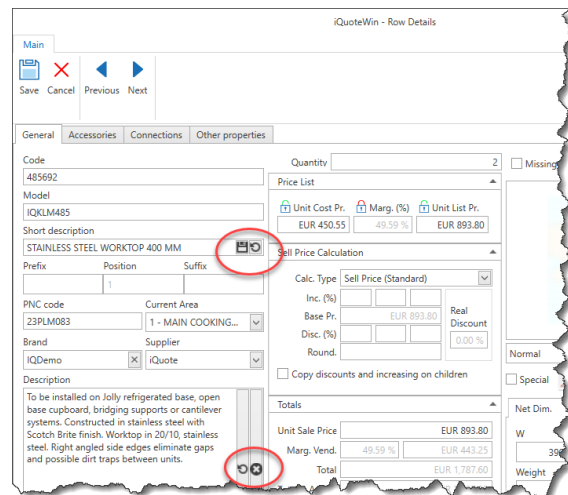

1.5.11 Surcharges, discounts, and calculation methods

Discounts and surcharges can be preset at quotation setting level (see paragraph 1.4.3) and/or set for the individual row or group of rows and/or for the area total. User can apply 3 distinct levels of discount and 3 distinct levels of increase to items.

These discounts can be entered directly in the appropriate columns of the quotation grid, or in the relevant "Edit offer row" window (see paragraph 1.5.9):

Unit Cost Price	Unit List Price	Qty.	Inc. 1 (%)	Disc 1 (%)	Disc 2 (%)	Unit Sale Price	Total	Total + Accessories	Sell Marg. (%)
EUR 6,402.11							EUR 15,636.93	EUR 15,636.93	
EUR 450.55	EUR 893.80	2		10.00 %		EUR 804.42	EUR 1,608.84	EUR 2,459.04	43.99 %
EUR 120.00	EUR 321.47	2				EUR 321.47	EUR 642.94		62.67 %

Discounts and surcharges are applicable according to four different calculation methods; depending on the calculation method selected, the result is different. It is possible to calculate the sale price starting from both the list price and the cost price.

As for discounts and surcharges, calculation methods can also be set at offer header level (look at point 1.4.3) or within the "Edit offer row" window (look at point 1.5.9).

Here are some examples of the various calculation methods:

- Sale Price (Standard): an item has a list price of €1,500, the 10% discount is applied by making the following calculation: $1500 - (1500 \cdot 0,1)$, for a total of €1.350;
- Selling Price (Reverse): in this case calculation is made in such a way that the difference between the sale price and the list price, respect to the sale price, is equal to the percentage indicated; always starting from a list price of € 1.500 and a 10% discount, you have the following calculation: $1500/1,1$ for a total of € 1.363,64;
- Cost Price (Standard): an item has a list cost of € 1.000 and you want to increase it by 20%: in this case the calculation is $1000 + (1000 \cdot 0,2)$, for a total of € 1.200;
- Cost Price (Reverse): as in the case of the Reverse Selling Price, the calculation is made in such a way that the difference between the sale price and the list cost, respect to the sale price, is equal to the percentage indicated: always starting from a cost of € 1.000 and a 20% increase, the following calculation is obtained: $1000/0,8$, for a total of € 1.250.

If increases and discounts are present, increases are first applied and discounts apply to these increases.

1.5.12 Cut/Copy/Paste/Delete Rows



This group of commands allows the cut/copy/paste/delete of one or more rows, taking advantage of the common Windows clipboard system. You can use command within the same offer or between different ones.

You can move open quotations to look at them side by side, thus activating a simultaneous view of them. To move quotations, click on the card title and, holding down the left mouse button, move it to the desired position; or right-click the card title, select "Move" and then drag it as a normal system window.

With side-by-side quotations, you can drag zones or items from one quotation to the other (dragging them they are moved; dragging them and pressing "CTRL" they are copied). Both operations are based on the "drag&drop" standard. Dragged items are copied or moved with the original information (even language), except for

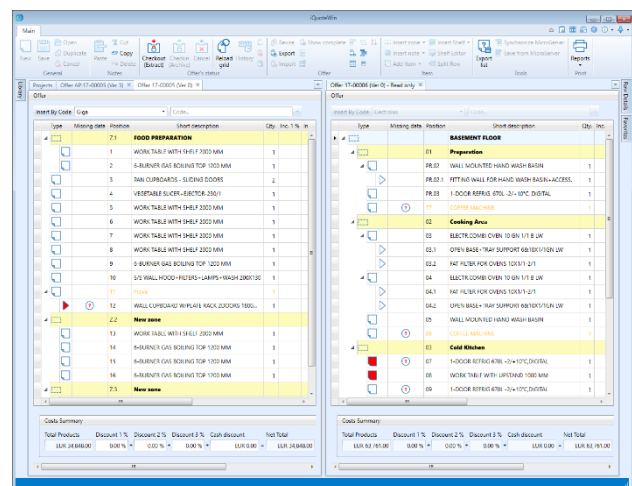

positions if automatic numbering is enabled in the target quotation. In this case, assumed numbering becomes that of the items receiving offer.

1.5.13 Item replacement

It is possible to choose to replace an item on offer with an item taken from the library. The substitution is equivalent to the cancellation of the previous item and the insertion of the new one. The only properties that are kept are location and quantity. If the offer is linked to a CAD or Revit project, if the command is executed in iQuoteCAD/iQuote Revit, the CAD/BIM symbol is also automatically replaced, while if the command is executed in iQuoteWin, when the project is opened a discrepancy is reported, that have to be resolved manually.

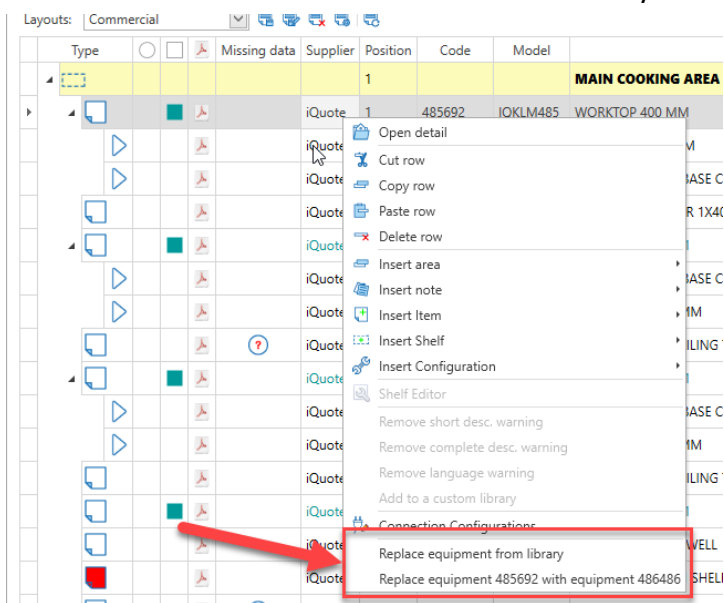



The offer lines containing products declared by manufacturer as "out of production" are now highlighted in a different colour and, if the information is available, their replacement with a suggested code is proposed. The command allows you to automatically replace the obsolete item with the new one, without having to look for it in the library.

1.5.14 Offer Utility

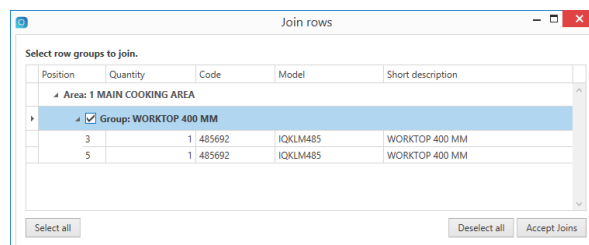
 **Join rows** "Join Rows" automatically scans all items in the offer: if it finds two or more identical items in the same area, it proposes merging them into a single line, automatically setting quantity of the items found to the sum of the same. Note that merge is not done automatically after the scan, but user can decide if and which items to merge from the window that opening after scanning.



 **Split Row** Having selected an item with a quantity greater than 1, "Split Rows" performs the inverse operation of "Join Rows": assuming you have an item with quantity 3, it allows to extract (proposing to user which option to choose) item on three lines (with quantity 1) or on two lines (one line with quantity 1, the other line with quantity 2).

 **Expand nodes** Nodes are those objects containing sub-objects:

 **Collapse nodes**

- Sections (zones), containing sub-sections and/or articles.
- Items, containing accessories.

Active only within the offer, "Expand Nodes" opens all nodes on offer.

Active only within the offer, "Collapse Nodes" compacts the view, closing all nodes of the offer.

 **Show complete** "Show Complete" allows you to view the entire offer, if you have previously activated a zone-filtered view (see step 1.4.7)

 **Import items from list** Allows to import a list of items from an excel or txt file into the current offer. The file must have following structure:

Code	Amount	Brand	Type Row
------	--------	-------	----------

*Row Type	
Accessory	0
Special Accessory	1
Optional Accessory	2
Alternative Accessory	3
Existing Article	4
Existing Accessory	7
Special Optional Accessory	8
Alternative Article	9

*Row Type	
Special Alternative Article	10
Article	11
Optional Article	12
Special Optional Article	13
Special Alternative Accessory	14
Special Article	15
Note	16
Zone	17

1.5.15 Synchronize data

Synchronize data Use this command to check for differences of all quotations' items respect to manufacturers' library. This checks whether data on quotation are compliant with library data, as a result of updates or other. During comparison, all item data (excluding connections) are verified. Each difference is summarized in a special window from which user has the opportunity to decide, for each information, whether to accept changes or keep values on quotation.

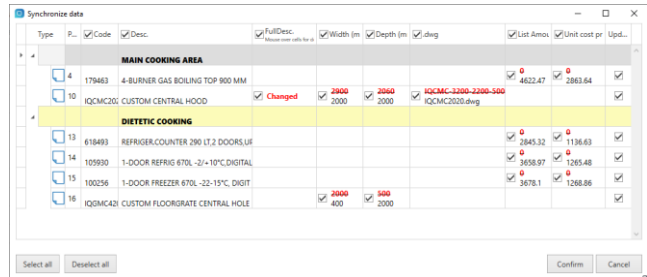

1.5.16 Item list

Lista Articoli Allows the creation of data extractions from the offer, including connection information. Usually, this command is used in the CAD environment to create technical item lists, which is why for detailed information about using this feature look at point 2.15 of this manual.

1.5.17 Export List

Export list Active both in dashboard and within offer, it allows to export offer line information in different formats. You can configure columns to be exported, you can filter or choose between different export preferences.

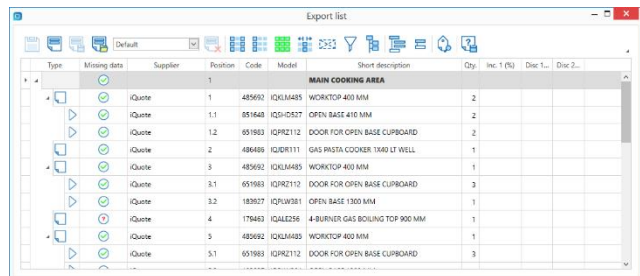

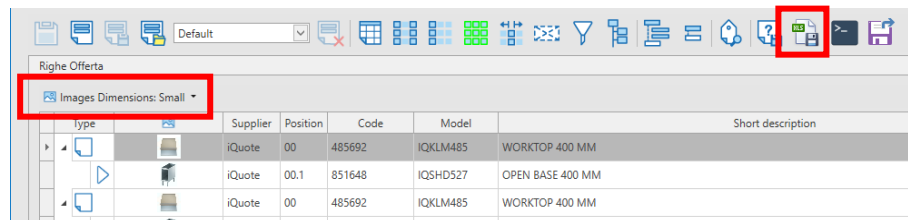

In the Export List window, you can also create different layout configurations you can reuse in the future.

In case of exporting offers rows, it is possible to directly export the list to an Excel file, allowing you to decide the size of the "image" column in the generated Excel file if it has been selected.



1.5.18 Connection Configuration

From the offer you can save and set a configuration connections to a specific line using the command  **Conn. Config** , or set a default previously set to all lines of the offer using the command  **Set default conn.** . Both commands are a simplified version of the version in iQuoteCAD (look at section 2.14) and iQuoteRevit (look at point 3.11), as it is not possible to save the geometric position of the connection.

1.6 PRINTS

1.6.1 Print offer

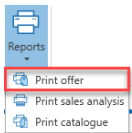

With an open offer, click the "Print" button in the upper right and select "Print Offer": in a few seconds you can see the print preview of the offer ready to be printed.

Ribbon provides the classic system operations to manage printouts: choosing printer to print on, page setups, scrolling for page-by-page preview, "First Page" and "Last Page", managing the zoom on print preview.

In the left part of the window, you find the panel "iQuote print settings", in which you can manage templates and settings that determine it. Any changes may not be saved but may be made effective on the print in progress.

1.6.2 iQuote Print Settings

The settings in the iQuote Print Settings panel allow you to manage the almost live printing offer; in fact, in order to apply all the changes it is necessary to press the "Apply" button at the bottom of the panel.

You can switch from one template to another using the drop-down menu, create a new model, load it from the outside or export it.

A little further below is the control for selecting the date to be displayed in the print offer; you can choose among the creation date, the last modified date, the current date or a selected date not belonging to any of the previous groups. This setting is not tied to any template.

You can set a header and a footer in the appropriate properties that also allow you to have a preview.

In the “Customization” group it’s possible to insert an information note at the bottom of the offer printout and upload a customized template. To insert an information note in another part of the offer, not at the bottom, refer to paragraph 1.5.6, section "Insert Note."

You can also select the "Classic" or "Compact" version of the print, in order to minimize the white space on the page.

As the last section we have the properties.

The properties are divided into “thematic” groups:

- **Accessory Properties:** there are controls for managing the visibility of the accessory properties, from the code to technical data, separately from the item’s properties to which the accessory belong.
- **First Page:** contains controls related to the presentation of the first page, such as the presence of some fields or their positioning withing the page.
- **Item Properties:** there are controls for managing the visibility of the article properties, from the code to technical data.
- **Layout:** contains controls related to the formatting of the print offer, such as the format of the date being printed or the insertion of print interruptions.
- **Prices:** there are controls for managing the visibility of prices or rounding.
- **Totals:** contains controls related to the visibility of totals, whether they are economic totals or technical totals.
- **Visibility:** there are controls for managing the visibility of the opening/closing text, first page, conditions and more.

All these settings are “volatile”: if they are not saved in a template, when the preview windows is closed, they are lost, so they will be re-entered at the next print.

Any modification of a template, other than one preloaded by the application, is indicated with an asterisk “*” next to the template name.

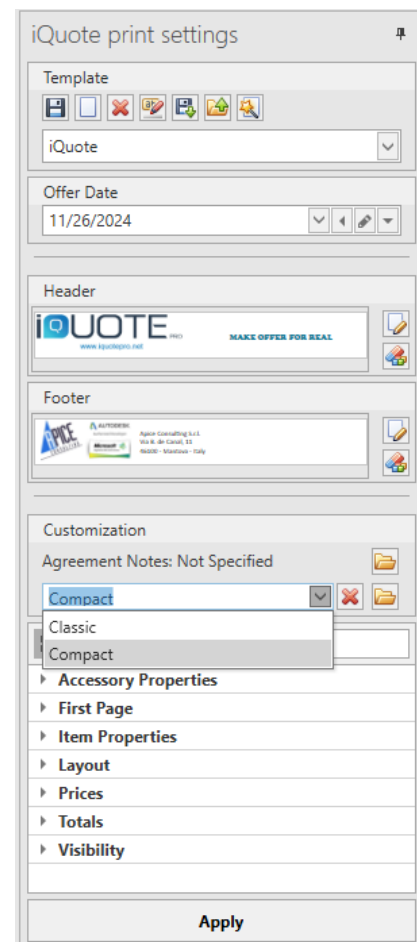

1.6.3 Print Export

From the “Export...” section of the ribbon, you can access the export to files in the most common formats, such as pdf, web, excel, word, image and more. Once you have chosen the export format, you will be prompted where to save file.

In addition to the above, through second "Send" button, you can export offer to the formats described above and send them immediately as e-mail attachments (for this, the default independent and external system mail client from iQuote Pro is used); when a mail client or the same client is not configured, contact your network administrator. Note that, even in this case, after choosing format, you are asked a location where to save the file; immediately after saving the email client's write window opens, with the attachment already inserted.

1.6.4 Storage of the offer in PDF as an attachment

In the Print preview window a specific feature “Save PDF as attachment” allowing to store the PDF version of the offer in the attachments.

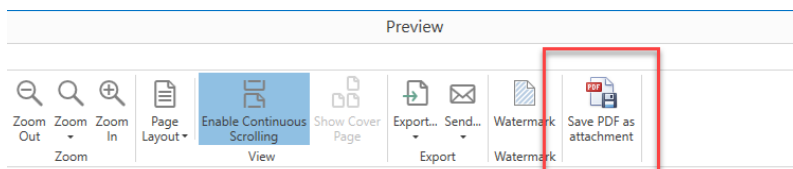

A file name linked to the offer and review code is automatically proposed; if an attachment with the same name is already present, it is possible to choose whether to overwrite or not.

1.6.5 Print sales analysis

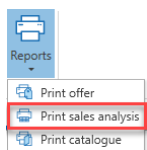

In Reports menu, you can print sales analysis, which provides a summary of the offer, listed by zones and positions, and allows to have a report of the offer, according to cost prices, discounts, surcharges price list, thus providing the situation of quotation margins.

There is palette, in print preview on the left side, to create custom templates, editing some layout properties and managing long text field, allowing to define behavior of text too long for column:

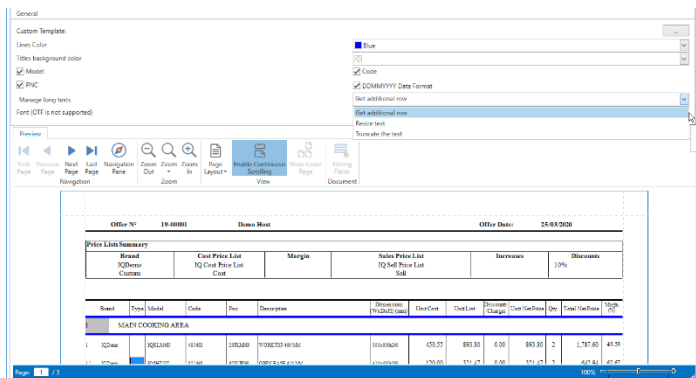

- **Get Multiple Lines**– is the default template, setting adding lines needed to display description: it is corresponding to "wrap" of text documents.
- **Resize text**– Decreases font size so that entire description is in a single line. It is therefore not recommended if text is quite long, as it would make description unreadable.
- **Truncate text**– Truncates text after maximum number of characters that can be displayed in a single line.
- **Print supplier summary**– appends a summary of costs and prices by supplier to the sales analysis.

Once you have defined print templates, just click on "Apply" at the bottom of the palette to have the preview of the analysis; then through the ribbon buttons it is possible to print sales analysis, export it, export it by sending it as an email attachment and save it as offer's attachment. These features, then, follow the steps described for the Print Offer in section 1.6.1, 1.6.2, 1.6.3, 1.6.4.

1.6.6 Print catalogue

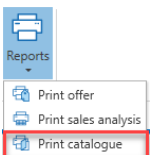

The last voice in the "Reports" menu is the catalog printing, allowing to generate a single document, containing the items datasheets present in the offer. Fundamental requirement for its creation, therefore, is that manufacturer makes available the aforementioned datasheets, with files in pdf format.

If technical data sheets provided by the manufacturer are not available, or you do not want to use them (for example for a special item), you can ask iQuote to automatically generate missing data sheets (look at paragraph 1.6.7).

When inserting items from library, you can already note if there is an associated datasheet in manufacturer's database: if it is present, its "technics" field suggests the associated file name. Note that datasheets vary depending on the language used in current offer, so, although file name appears in the file name in the library field, it may not be available in a particular language and, as result, it may not be printed.

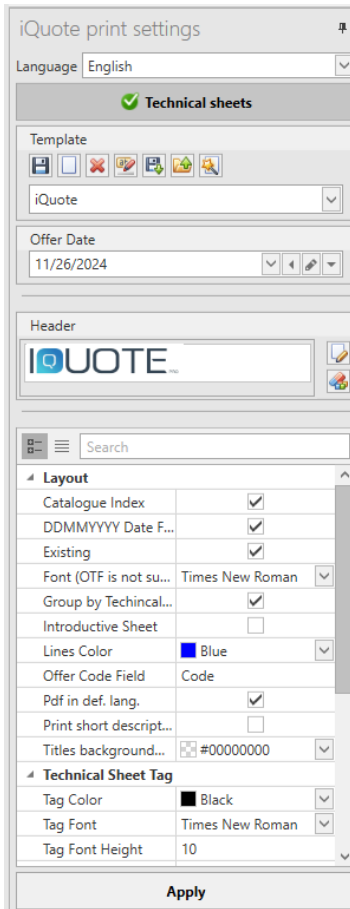

Accessing the print catalog summary window opens, where you can see the preview. As for sales analysis printing, you can also create custom templates for catalog by working into palette on the left side: the operation remains the same as for the realization of offer templates printing; it should be specified that in the catalog you can choose between the creation date, the last modification date, the current date, or a selected date that does not belong to any of the previous groups (this setting is not linked to any specific template), you can customize header and footer, lines colors, page titles background, to exclude/include the grouping of the technical data sheets, possibility to activate the indication, directly in the technical data sheet, of the position number and the belonging area.

At the top of option palette, it is possible to choose the language for datasheets from the drop-down menu. Clicking on "Technical sheets" button it opens summary, ordered by areas and positions, of the catalogue with pdf file's path. If path remains blank, it means in current installation datasheets are out of date or, as specified above, are missing in language used in the offer or in manufacturer's database. In this case, check the existence of datasheet in library (as indicated in previous paragraph) and possibly with the manufacturer itself. With

two buttons into the ribbon bar it is possible to exclude all the items without the datasheet (if not, iQuote prints a row with code/position/description with a blank page) and it is also possible to generate automatically the datasheets for the items without them.

If offer is in a checkout state, so in editing, you can right-click

on the individual bid lines and select from the menu command "Change technics file": this allows you to select a pdf file from the disk and make it the datasheet of that item (only for current offer).

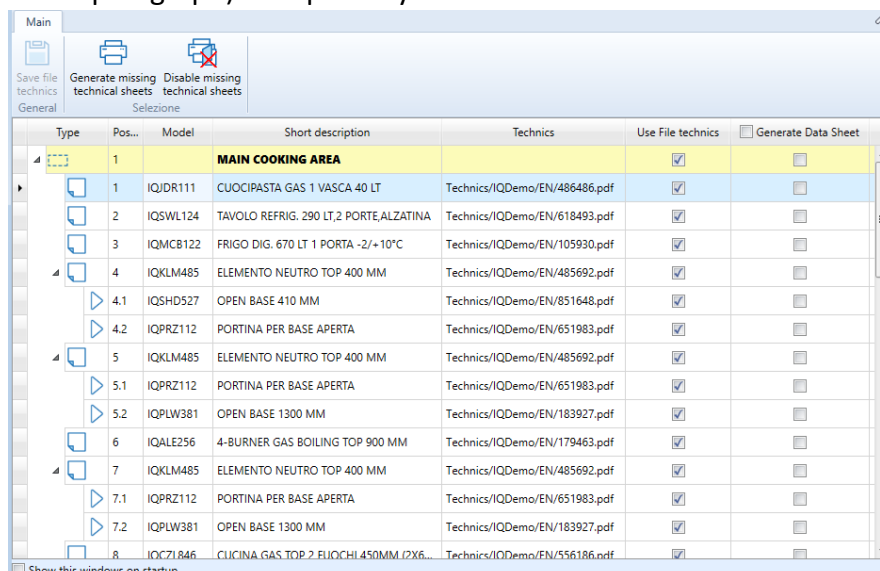



Type	Pos...	Model	Short description	Technics	Use File technics	Generate Data Sheet
MAIN COOKING AREA						
	1				<input checked="" type="checkbox"/>	<input type="checkbox"/>
	1	IQDR111	CUOCIPASTA GAS 1 VASCA 40 LT	Technics/IQDemo/EN/486486.pdf	<input checked="" type="checkbox"/>	<input type="checkbox"/>
	2	IQSWL124	TAVOLO REFRIG. 290 LT,2 PORTE,ALZATINA	Technics/IQDemo/EN/618493.pdf	<input checked="" type="checkbox"/>	<input type="checkbox"/>
	3	IQMCB122	FRIGO DIG. 670 LT 1 PORTA -2/+10°C	Technics/IQDemo/EN/105930.pdf	<input checked="" type="checkbox"/>	<input type="checkbox"/>
	4	IQKLM485	ELEMENTO NEUTRO TOP 400 MM	Technics/IQDemo/EN/485692.pdf	<input checked="" type="checkbox"/>	<input type="checkbox"/>
	4.1	IQSHD527	OPEN BASE 410 MM	Technics/IQDemo/EN/851648.pdf	<input checked="" type="checkbox"/>	<input type="checkbox"/>
	4.2	IQPRZ112	PORTINA PER BASE APERTA	Technics/IQDemo/EN/651983.pdf	<input checked="" type="checkbox"/>	<input type="checkbox"/>
	5	IQKLM485	ELEMENTO NEUTRO TOP 400 MM	Technics/IQDemo/EN/485692.pdf	<input checked="" type="checkbox"/>	<input type="checkbox"/>
	5.1	IQPRZ112	PORTINA PER BASE APERTA	Technics/IQDemo/EN/651983.pdf	<input checked="" type="checkbox"/>	<input type="checkbox"/>
	5.2	IQPLW381	OPEN BASE 1300 MM	Technics/IQDemo/EN/183927.pdf	<input checked="" type="checkbox"/>	<input type="checkbox"/>
	6	IQALE256	4-BURNER GAS BOILING TOP 900 MM	Technics/IQDemo/EN/179463.pdf	<input checked="" type="checkbox"/>	<input type="checkbox"/>
	7	IQKLM485	ELEMENTO NEUTRO TOP 400 MM	Technics/IQDemo/EN/485692.pdf	<input checked="" type="checkbox"/>	<input type="checkbox"/>
	7.1	IQPRZ112	PORTINA PER BASE APERTA	Technics/IQDemo/EN/651983.pdf	<input checked="" type="checkbox"/>	<input type="checkbox"/>
	7.2	IQPLW381	OPEN BASE 1300 MM	Technics/IQDemo/EN/183927.pdf	<input checked="" type="checkbox"/>	<input type="checkbox"/>
	8	IQC71846	CUCINA GAS TOP 2 FUOCHI 450MM I2X6	Technics/IQDemo/EN/556186.pdf	<input checked="" type="checkbox"/>	<input type="checkbox"/>

After you edit one or more datasheets, you must use "Save file technics" command to confirm changes. Even from context menu, you can also restore original technics file, in case you want to undo change made.

Once you have defined template, or leaving the default "Default", click on "Apply" to see the final preview of the catalogue: from here you can save pdf file in a location as you like, or print catalog directly on the system printers, or save the catalogue as PDF attachments of the offer. These features are the same described in offer print section, 1.6.1, 1.6.2, 1.6.3, 1.6.4.

1.6.7 Autogenerate equipment data sheet

If there is no technical data sheet or, as can happen in the catalog printing, you do not want to use technical data sheet provided by manufacturer, you can launch the generation of a self-generated technical data sheet.

Command can be launched from library , offer  or catalog printing.

For first two cases, web browser opens in which technical data sheet are immediately visible and downloadable; in the case of use within catalog printing, the file is inserted directly into the catalog (look at paragraph 1.6.6).

It is also possible, in case of offer printing and catalog printing, to decide, through application options (look at paragraph 1.9), whether to use item data (if any) or offer line data.

1.7 CUSTOMERS /SUPPLIERS ACCOUNT

Within the iQuoteWin software there is a section dedicated to customers/suppliers account, where you can store personal information, addresses, contacts and banking information of customers and suppliers. Use the "New Account" and "Save" buttons on the ribbon to create/save customer/supplier information.

Data contained in account can be used during offers drafting (look at paragraph 1.4.2), having a dynamic link with the account. This means that if you make changes to a customer's account, they affect all offers linked to this one.

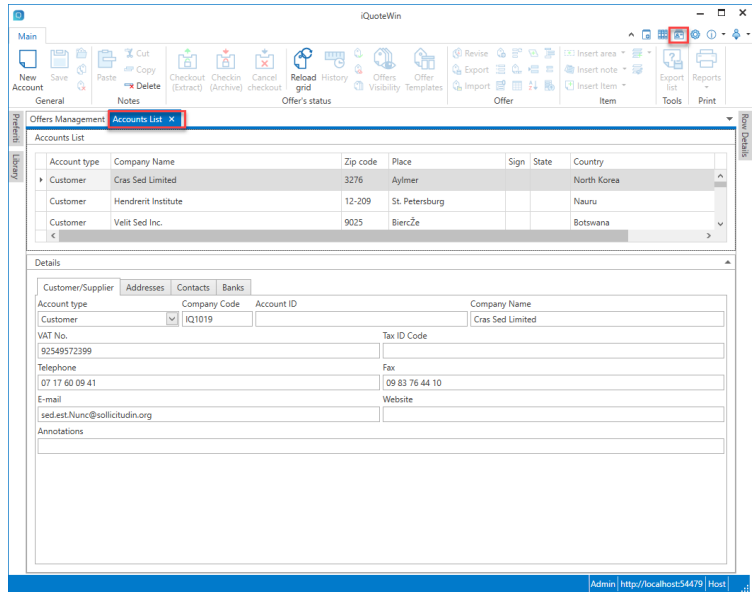

1.8 CUSTOM LIBRARY

By starting Libraries command, you can access the Libraries List work environment. Inside it, a grid shows all the libraries installed on the server, divided by type:

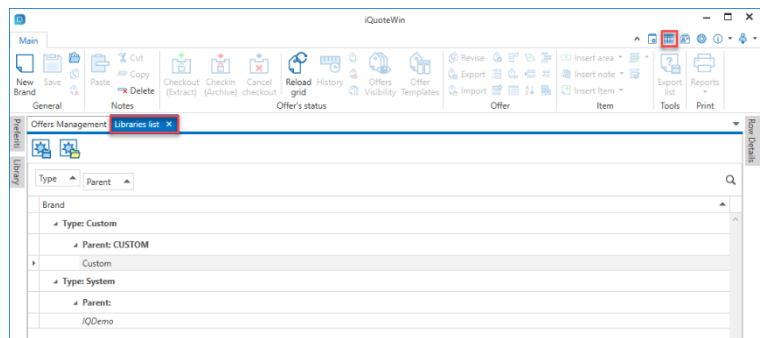

- **System:** these are manufacturer libraries received through live update and are not editable by the user.
- **Custom:** these are custom and user-created libraries.

You can use "New Brand" button on the ribbon to create a new library, or double-click an existing library to open it to edit.

This opens a new work environment to edit/create library.

There are 3 sections:

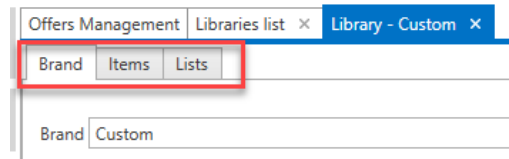

- Brands:** in this section we find the **name** of the library (which must be unique within the server), the **logo** (to set it you just have to hover with the mouse over preview box to bring up a dedicated toolbar), the grid dedicated to **navigation** (you can create new branches and/or drag branches from one location

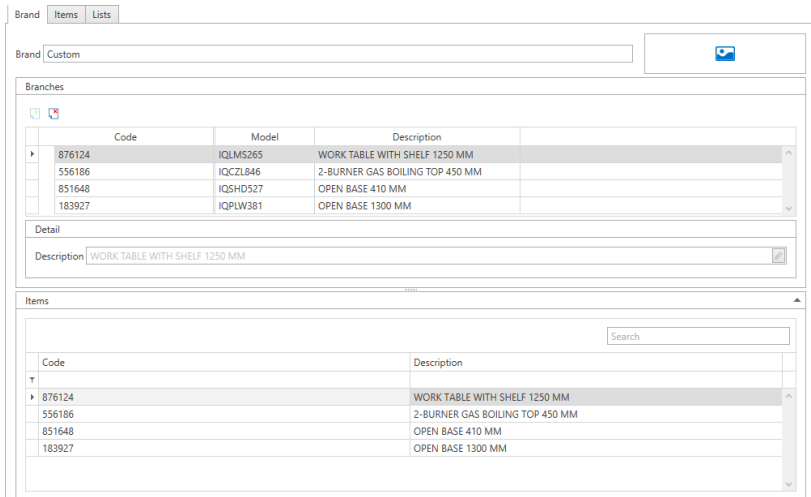

to another to create a tree structure), and finally a grid that summarizes items so that it sums up items so that these can be dragged into navigation.

- Items:** In this section we find a grid, listing items in library. You can create/delete an item using appropriate commands. At the section bottom we find details tab, with all the item information. Some data by their nature may be related to selected language (e.g. the item description), so these fields have a special icon () next to, allowing to enter field value in all available languages in iQuote Pro.

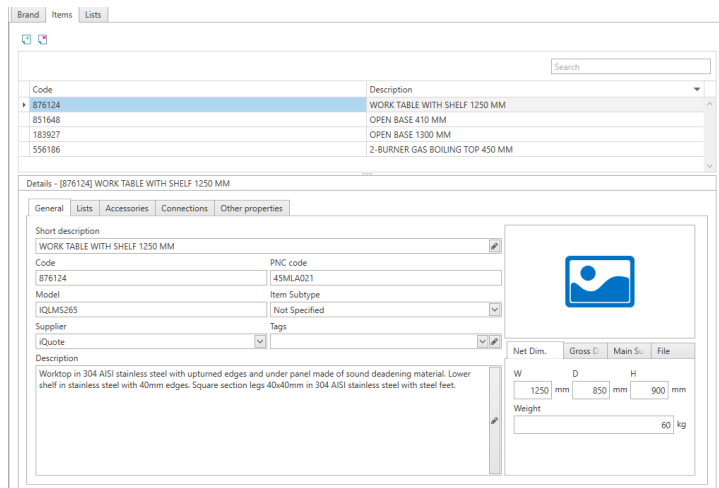

By right-clicking an existing item (both a system library and a custom one) you can start the "Copy Item" command, to copy a system library item to a custom library.

- **Lists:** In this section, you can create/edit cost and sales lists for current brand. When a price list has been created, in Items section you can enter price for each item referred to the various price lists

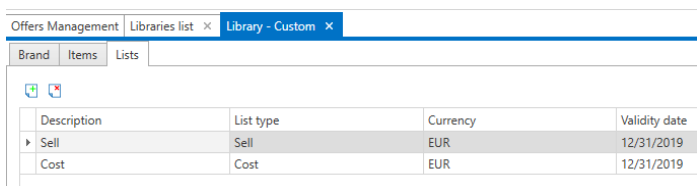

Description	List type	Currency	Validity date
Sell	Sell	EUR	12/31/2019
Cost	Cost	EUR	12/31/2019

created. It is also possible to add customized price lists using the appropriate button (); to proceed with the import it is necessary to fill in the "Pricelists" and "Items Prices" sheets of the file for importing libraries on the site <http://service.iquotepro.net/downloads/iQuoteLibraryImport.zip>.



Note that when you have finished making changes in the 3 sections, you should use "Save" command in the ribbon for confirmation as usual.

1.8.1 Creation of calculated price lists

Within the interface for libraries customization it is possible, both for custom price lists and for system price lists, to add price lists calculated from an existing price list.

To do this, simply select a list under the column "Reference list" (for system price lists field will be disabled) and enter a formula under the "Formula editor" field.

Any updates on reference price list will also have repercussions on calculated price list by updating prices, according to the formula indicated and the new prices.

It is also possible to  export and import price  lists calculated between different locations; this operation is possible  List Import from IQL File only if reference price list is present.

1.9 IQUOTEWIN OPTIONS

Starting "Options" command a new workspace opens, with a series of settings, that are stored at individual user level and not affect do not affect how other users work.

The Options window is divided into 4 sections:

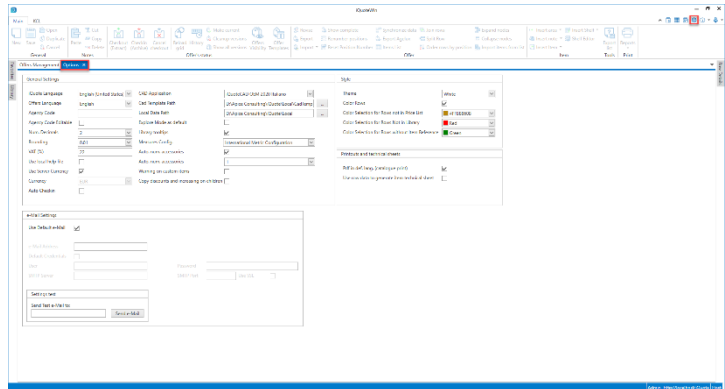

- General settings

- **iQuote Pro language:**

This is the language in which the iQuote Pro program interface is displayed. By default, language of the operating system is used, but you can

choose a different language from the drop-down menu.

- **Offers language:** this is the default language being proposed for a new offer creation
- **Agency Code:** this is the prefix concurring to the offer code. At most, it can contain 5 characters.
- **Agency code editable:** if enabled, it causes prefix to be applied to code to be changed by the user each time you create a new offer.
- **Num Decimals:** You can indicate how many decimal places to display in prices within the offer.
- **Rounding:** You can indicate how many decimal places to round price value within the offer.
- **VAT (%):** Indicate the percentage value of VAT being applied to the offer.
- **Use local help file:** If set, local copy installed on your computer is used every time you press F1 to access help. This has the advantage you can access help even in the absence of internet connectivity, but on the other hand guide may not be updated with the latest news. Therefore, we recommend that you do not set this flag, in order to access the online help constantly kept up-to-date.

General Settings			
iQuote Language	English (United States)	CAD Application	iQuoteCAD OEM 2022 English
Offers Language	English	Revit Application	Autodesk Revit 2022
Agency Code		Cad Template Path	E:\Apice Consulting\iQuote\Local\CadTempl...
Agency Code Editable	<input type="checkbox"/>	Local Data Path	E:\Apice Consulting\iQuote\Local
Num. Decimals	2	Explore Mode as default	<input type="checkbox"/>
Rounding	0.01	Library tooltips	<input checked="" type="checkbox"/>
VAT (%)	22	Auto. num. accessories	<input checked="" type="checkbox"/>
Use local help file	<input type="checkbox"/>	Auto. num. accessories	1
Use Server Currency	<input checked="" type="checkbox"/>	Warning on custom items	<input type="checkbox"/>
Currency	EUR	Copy discounts and increasing on children	<input type="checkbox"/>
Auto Checkin	<input type="checkbox"/>	Auto set default connection	<input type="checkbox"/>

- **Use Server Currency:** If set, default currency for new offers is the currency decided at the server administrator level, if not set you can set your own default currency.
- **Currency:** Sets the default currency for new offers, active only if "Use Server Currency" is active.
- **Auto checkin:** If active, a check-in request appears every time an offer is closed.
- **CAD application:** you can indicate which CAD is used by default when opening projects, if you double-clicking on a project file on the Attachments tab.
- **CAD Template Path:** this is the path where CAD templates (.dwt) are present, when creating a new project file.
- **Local data path:** is the local path used by iQuote Pro to store files used by the system.
- **Explore mode as default:** Sets whether library should be started with Browse mode, that is page view, or tree view.
- **Library tooltips:** Set whether to display tooltips or not, with item picture and description, when hovering over library navigation grid.
- **Unit of Measure:** Sets the default System configuration (metric or imperial) being used for new offers.
- **Auto num. accessories:** sets whether position numbering for accessories should be handled automatically by the system (they are then b numbered progressively compared to the parent item. If item has number 1, then 1.1, 1.2, 1.3, ...)
- **Warning on custom items:** If set, "Missing data" flag is set automatically on items created directly in offer.
- **Copy discounts and increases on children:** If set, default option in item creation/edit window is enabled, allowing discount/increase of the item to be propagated to accessories.
- **Auto set default connection:** when this option is active, connection configuration set as automatical default on the item inserted from library is loaded.

- Style

- **Theme:** Allows to set the choice of color scheme to use for the iQuote interface.
- **Color rows:** If set, lines in quotation grid are colored entirely to indicate the various states. Otherwise, if not set, status color is visible only in a specific grid column.

Style	
Theme	White
Color Rows	<input checked="" type="checkbox"/>
Color Selection for Rows not in Price List	#FFB860B
Color Selection for Rows Not in Library	Red
Color Selection for Rows without Item Reference	Green

- **Color selection for rows not in price list:** You can specify a color for items being no longer present in price list.
- **Color selection for rows not in library:** You can specify a color for items being no longer present in library.
- **Color selection for rows without item reference:** You can specify a color for items having no library references.

- Printouts and technical sheets

- **Pdf in def lang (print catalog):** if set, in case during catalog printing some datasheets are not found in offer language, system searches for the sheet in default language.
- **Use row data for item sheet generation:** if set, allows to use th data saved on the offer row for the generation of the item sheet, so as to have any information modified by the user on the item sheet.

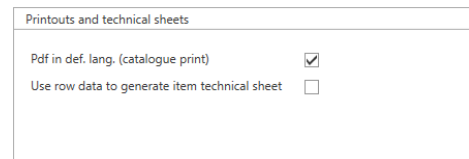

- Mail settings

- **Use default email:** If set, default parameters to send any emails from the iQuote Pro software are used. At the moment, email submission cases are limited to system events, such as software crashes or sending an offer to Apice Consulting support. If not set, you can customize your mail data in accordance with your business policies.

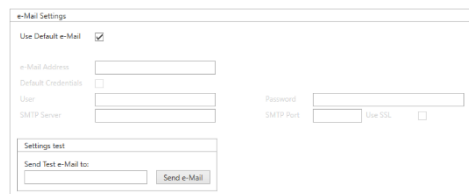

- Unit of measurement configuration

- **Measures Config.:** allows you to select the configuration of units of measurement to be used within the program.
- **Number of decimal digits:** allows you to choose how many decimals to display for the units of measurement that have required formatting (see point 4.1.7).

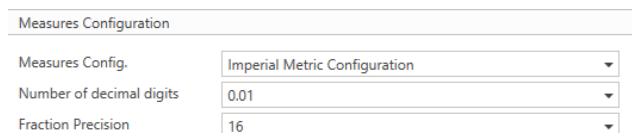

- **Fraction Precision:** if the presence of units of measurement is detected that require the display as fractional (see point 4.1.7) it allows to select with which precision the numerical value is to be interpreted.
- Utilities
 - **Clean Local Cache:** allows you to free up space locally by deleting files, such as blocks, images or technical data sheets of articles; **may slow down some operations that require these files to be re-downloaded from the server.**

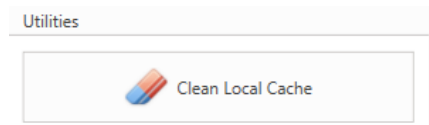

1.10 SERVICE MESSAGING

A new message bar may appear on the iQuoteWin home screen. These are service messages, notifications of the service or the status of the more. These can be "by sent directly from Consulting, or sent by the of the iQuote case there are messages at the same time, it is possible to open a display window to be able to look at the complete list.

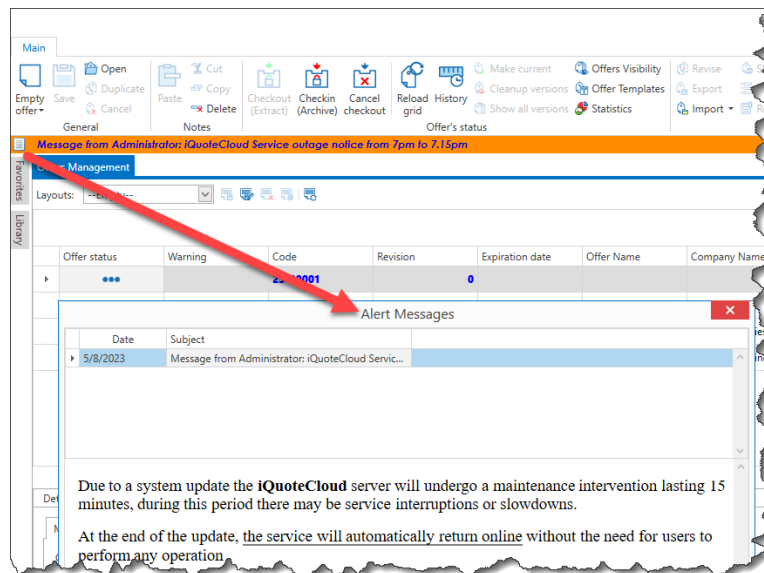

typically suspension of information on server and messages system", i.e. Apice "local", i.e. administrator server. In several

2 IQUOTECAD

2.1 CREATE CAD PROJECT FILE

CAD design files are handled as an attachment to the iQuoteWin offer: this structure is required in order to have real-time synchronization between drawing and offer.

To proceed with the creation of the DWG file, you must first create an offer in iQuoteWin, by assigning at least one brand/list as seen in chapter 1.3.1; then, in the details section of the dashboard, go to "attachments" and select "New Project": CAD template file selection window appears.

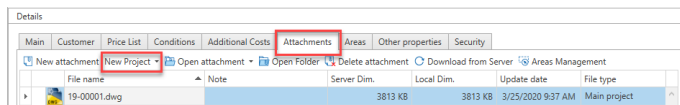

2.1.1 Drawing templates

iQuoteCAD models are Autodesk AutoCAD model files, therefore in standard dwt format:

- By default, 3 system templates are provided and are displayed in bold text in selection window. Any eventual custom templates are displayed in the window with the normal font.
- System templates (shown in bold) should not be modified by the user, this to avoid information loss during liveupdate operations (as they would be overwritten).
- You can create additional templates. To do this, create file with your specifications in iQuoteCAD and save it in the dwt format in the path defined for iQuoteCAD templates in the Custom subfolder (path that can be defined in the iQuoteWin options, look at paragraph 1.9)
- By selecting the second "From File" option, you can start the design from an existing DWG file. Starting from an existing file, in addition to the project in the file, you are using drawing settings of the creator of the DWG file too.

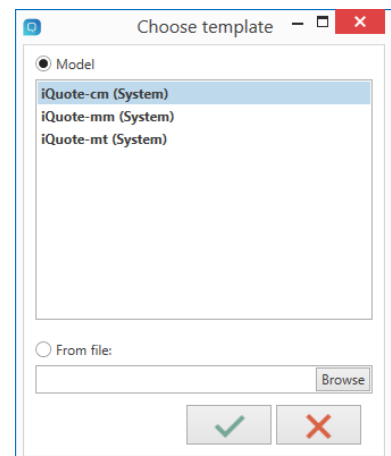

Once you have chosen starting template, confirm and open file by clicking the confirmation button, then click the "Save" command at the top of the multifunction bar.

2.1.2 Multi-DWG creation

iQuote Win allows to manage multiple DWG attachments for the same quotation. Assuming you run a project for a multi-floor restaurant, for example, you might have a unique offer for the whole restaurant, but a specific DWG file for each floor. iQuoteWin works for areas and sub-areas: for example, inserting the two main areas "Plan 1" and "Plan 2", we could define a design for each floor.

First DWG you create is automatically associated with all areas and remain the main one, which means that by opening the DWG file you can interact with all areas of the offer.

From the second DWG file created onwards, you are prompted (together with template choice) to select the areas to link the DWG in creation: select areas to associate it with and confirm, then click "Save". Each area can be associated with only one DWG: so, when an area is assigned to a secondary drawing, it's removed from previous drawing, to which it was linked.

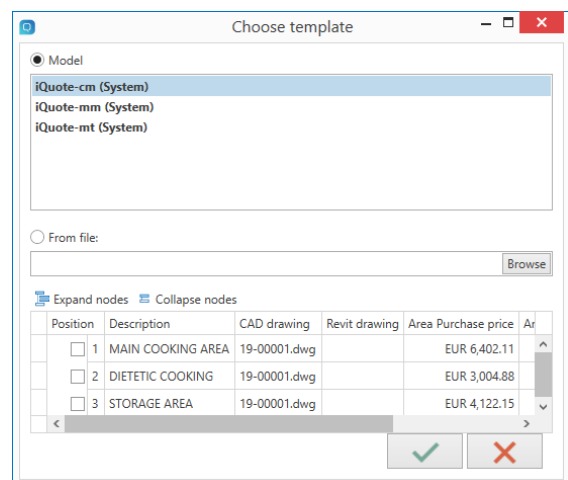

You can change association of a DWG file to areas at any time, although it is recommended to associate areas when they are still free of items, to avoid misalignments or inadvertent data loss.

In iQuoteWin, select main project from the quotes list and go to the Attachments section. Select the DWG file here and click the "Manage Areas" button above: a window appears showing current DWG file association, select/uncheck the areas and click on confirm.

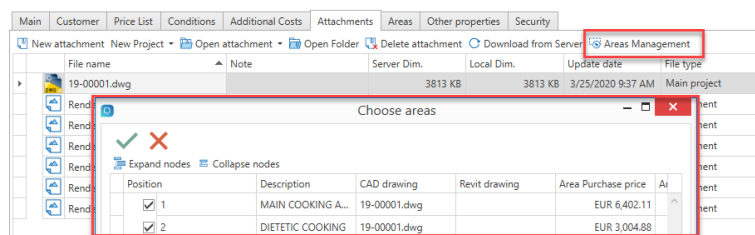

2.1.3 File DWG opening

You can open project attachments for a quotation in two different ways:

- Open the DWG file with a double click, or by selecting it and clicking "Open Attachment" in the Attachments tab in iQuoteWin
- Use the Open Project command on the iQuoteCAD ribbon: quotations in the archive are displayed and, for each of them, project attachments, that can be opened with a double click.

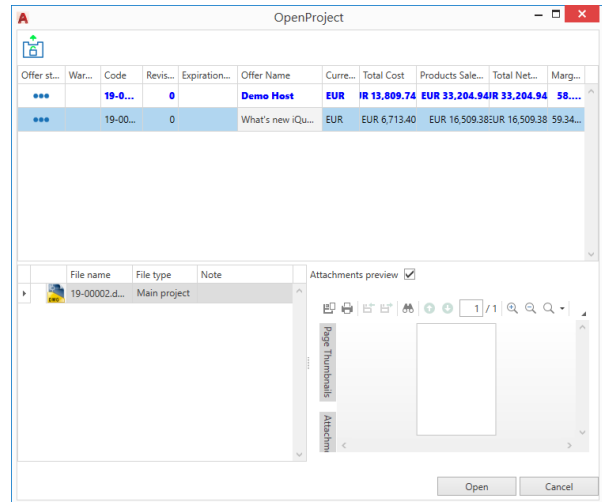

As with iQuoteWin, when you open iQuoteCAD you are prompted for the user's login: login window works the same as iQuoteWin, so refer to paragraph 1.1

2.2 INTERFACE

The interface is the AutoCAD classic, to which iQuoteCAD specific commands are added.

In particular, a new command tab is added to the ribbon, a context menu for selecting iQuoteCAD objects, 2 side

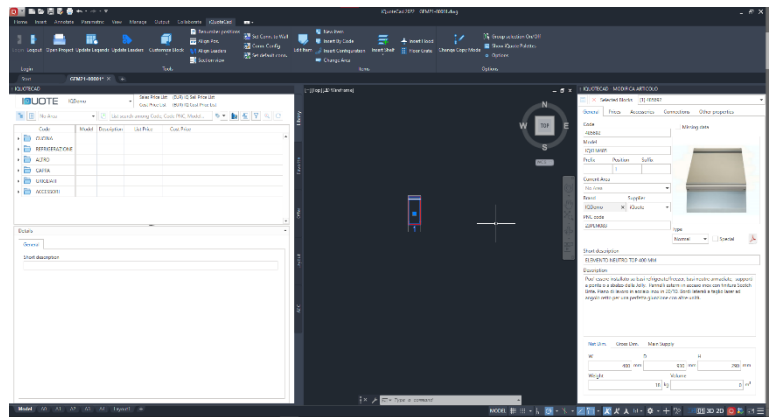

tool palettes and some quick buttons on the status bar (2D/3D power/off, Tooltip, Position Number).

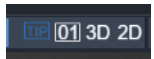

2.3 AEC COMMANDS

Within the iQuoteCAD palette (by default displayed on the left of the work area) there is the AEC tab, which includes a series of dedicated tools to create architectural elements (walls, doors, windows, ...) within our design.

This section is in turn divided into 4 tabs: walls, doors, windows, miscellaneous.

2.3.1 Walls

On this tab we find tools to create walls within the drawing. In the window, you can specify thickness and height of the wall, and then choose a starting method:

1. **Open:** first section of wall will be open on its end (typically used when drawing a room or when you want to draw a portion of wall)
2. **Closed:** first section of wall is closed on its end with a face (typically used to draw a dividing wall)
3. **Intersected:** first section of the wall intersects an existing wall

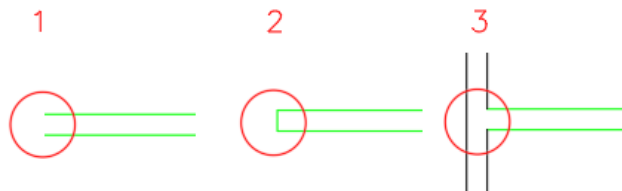
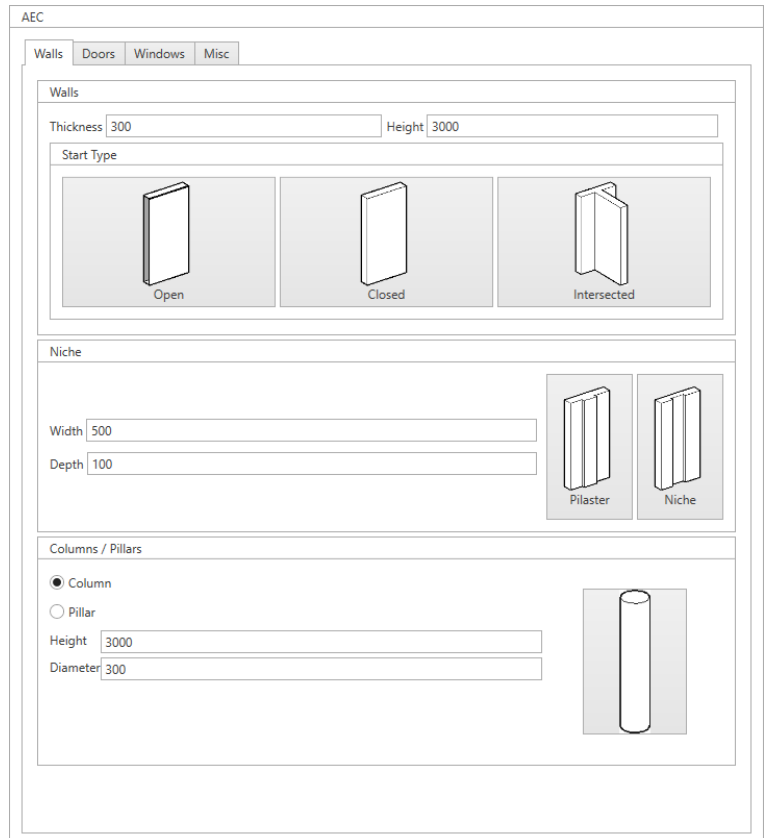

Once you have chosen starting type of the wall, you can start to enter the starting point in the graphics area of iQuoteCAD (only if mode 3 is selected, you need to select an existing wall and indicate a distance to identify the intersection point). After entering first point, the system continues

to ask for subsequent points until command is finished with the press of the Enter key. With each point entry request, you have several options from the command line or context menu:

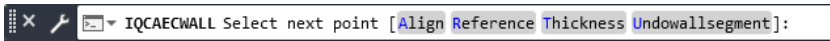

- **Align:** Selecting this option you're asked to select an existing wall and the system aligns Cartesian axes to the selected wall (this option is especially useful in case of sloping walls, as it allows to use iQuoteCAD's F8 orthogonal function in these cases as well)
- **Reference:** Select this option to reverse the reference side for wall tracing (external/internal)
- **Thickness:** Select this option to change (increment/decrease) the thickness of the wall. You are prompted to enter new thickness: in case, before entering value, you can change the type of "pass" from one thickness to another by choosing from

Gradual



Edge



- **Undowallsegment:** Select this option to cancel last selected point and therefore delete last drawn wall stroke.

Press Enter to end the command: a selection window is displayed for the type of closure to be adopted:

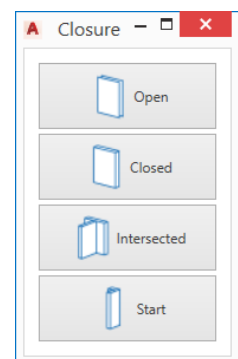

1. **Open:** Last stretch of wall is open on its end.
2. **Closed:** Last stretch of wall is closed on its end with a face.
3. **Intersected:** Last stretch of wall intersects an existing wall
4. **Departure:** An additional section of the wall is drawn to the starting point, to close an area.

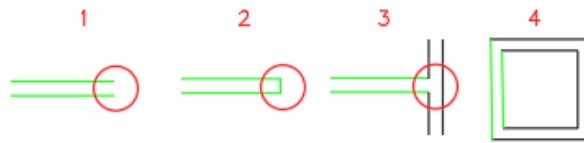

There are two additional commands on the walls tab:

- **Niches/Pilaster**

In the palette, you can indicate the width and depth of the feature. Then, pressing relative button, command continues in the iQuoteCAD graphics area with the prompt to select an existing wall from the side to perform the feature, and then indicate the distance from the nearest edge.

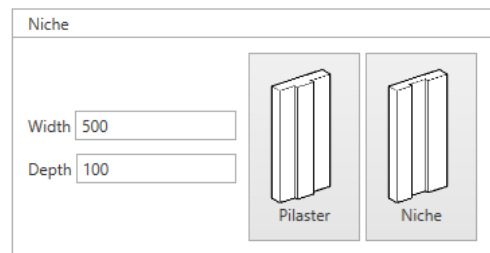

- **Columns/Pillars**

In the palette you can choose the type and indicate the height and diameter of the feature (if pillar you need to indicate the size of the two sides). Then, pressing relative button, command continues in the iQuoteCAD graphics area, with the prompt to select a point, where feature will be placed.

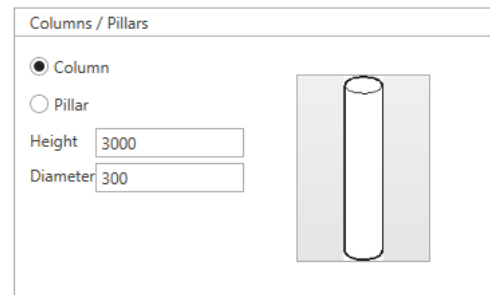

2.3.2 Doors

This tab allows the insertion of doors on walls created with the command explained in previous step.

It is possible to enter the size of the door (width and height) and, depending on these, a series of models of doors is displayed, to be inserted (for example, increasing the width, double-leaf doors also appear).

It is also possible to decide whether to simply create the door hole, or insert the door too, and whether or not to enable the frame.

Once defined dimensions and chosen model, pressing the "Draw Door" button, going into the graphics area of iQuoteCAD, you are prompted to select the two sides of an existing wall (inner and outer side). Request to enter the distance at which to place the door from the beginning of the wall then follows. If you have chosen to insert the full door, you are also asked to select where to place the hinges of the door.

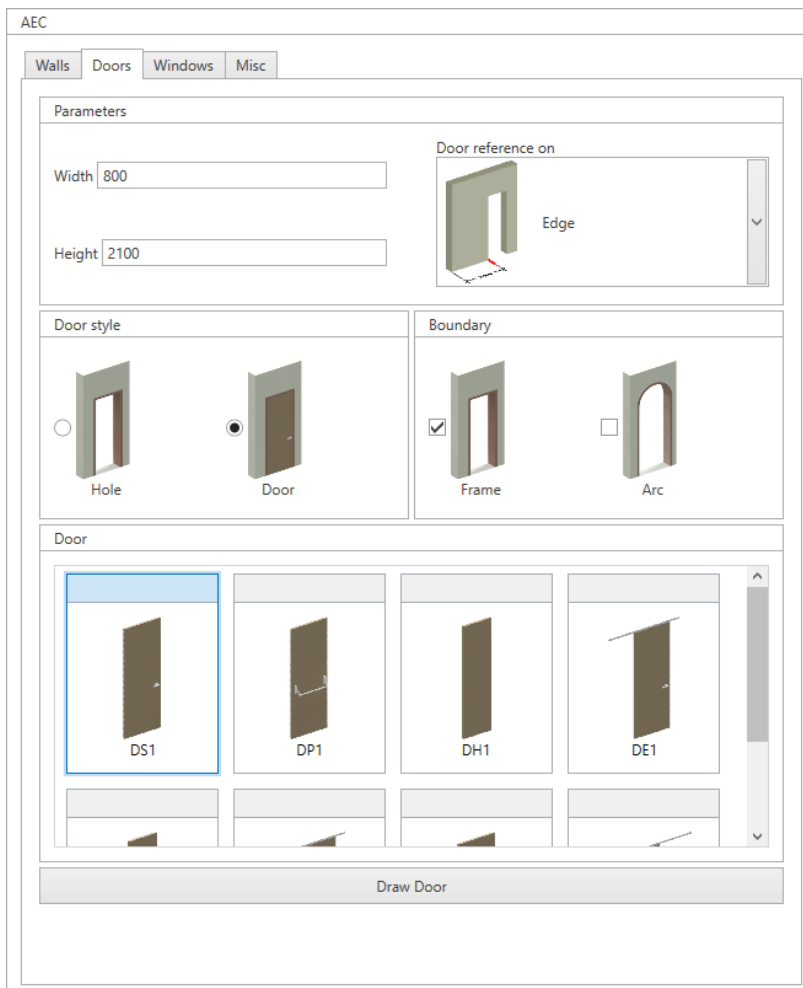

2.3.3 Windows

This tab allows windows to be placed on existing walls.

You can enter the size of the window (width and height) and, depending on these, a series of models of windows you can insert is displayed (for example, increasing the width, windows with a greater number of doors appear).

It is also possible to decide whether to simply create the window hole, or to insert the window model too and whether or not to enable the frame.

Once you have defined dimensions and chosen model, pressing the "Draw Window" button, going into the graphics area of iQuoteCAD, we are prompted to select the two sides of an existing wall (inner and outer side). The request to enter

the distance at which to place the window from the beginning of the wall then follows. If you have chosen to insert the full window, you are also be asked to select where to place the hinges of the window.

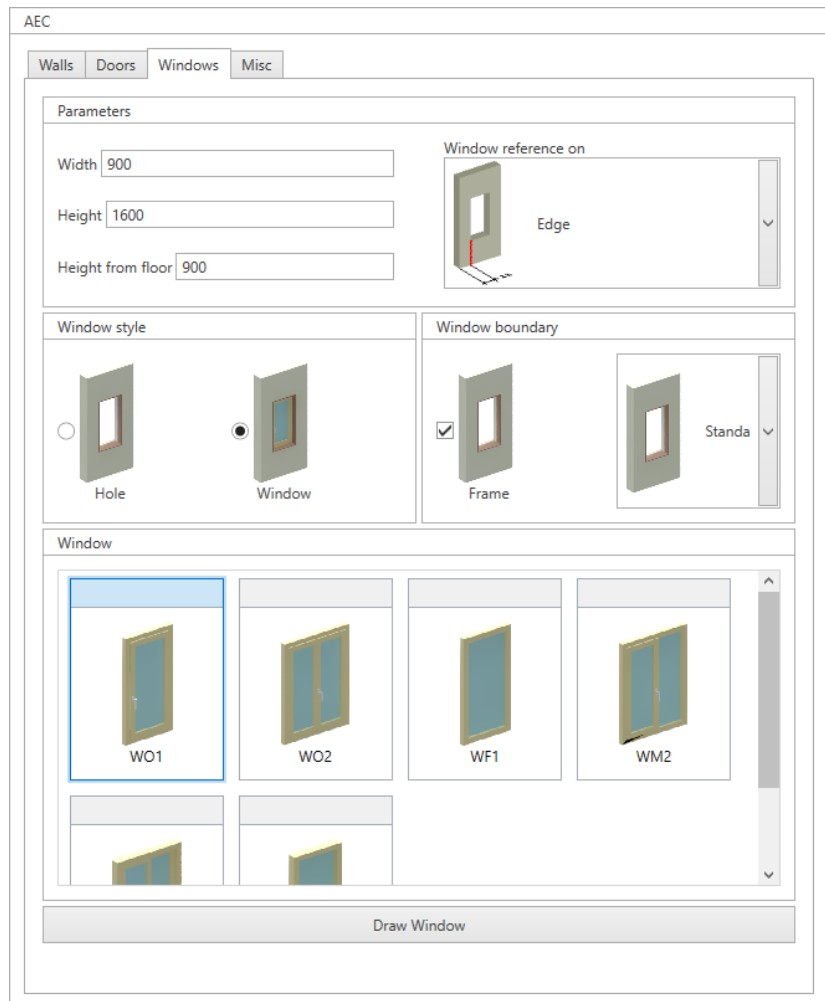

2.3.4 Miscellaneous

- **Covering**

Use this command to insert a tile wall covering or sheet metal. Specify the height of the coating, thickness, and

height from the ground before starting the command. Starting the command is then prompted in the iQuoteCAD graphics area to select the start and end point of the coating (you don't necessarily need to have a wall), then a point specifying which side covering is located respect to the two points you typed earlier.

You can then close command by typing Enter or, if you need to create openings in the covering (for example to circle around a door or window) you can indicate the start/end point and the heights of any openings (the command continues to require eventual openings until you press the Enter key).



- **Floors/Ceilings**

Set a ceiling elevation, then start command and select a point within an area (such as a room) to automatically create floor or ceiling.

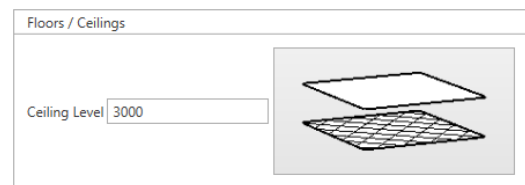

- **Skirting**

Set a skirting height and thickness, and then press the "Draw Skirting" button: you can select one side of an existing wall and a side indicating the exterior. The command repeats automatically until you press the Enter key.

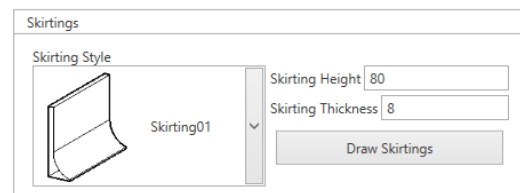



2.4 LIBRARY

Library allows to access library navigation, depending on the marks/lists activated for current offer. Use of the library is the same as seen in iQuoteWin, so refer to 1.5.1 and below. The only exception to iQuoteWin is that when inserting items, you are prompted to indicate a CAD block insertion point (look at point 2.6)

2.5 OFFER

The iQuoteCAD software allows a direct synchronization between design and offer. This means that every operation performed in the iQuoteCAD graphics area also affects the offer database directly and then iQuoteWin. You do not need to perform any kind of synchronization operation.

"Offer" tab shows a grid of quotation lines. Compared to the one already analyzed in iQuoteWin, there are some additional columns specific to the CAD environment:

-  • **Move Row:** In the grid, unlike iQuoteWin, you can drag&drop rows to change sort order only by clicking on the navigation icon, not anywhere. This is because the default drag-drop is reserved to insert rows into the drawing area.
-  • **Extended CAD Status and Status:** From these columns you can see if th drawing and offer are aligned. There are two possible icons: the green one indicates item is aligned; conversely, the red icon identifies a misalignment. To know the reason for the misalignment, you can stay a few moments with the mouse on the icon to display a tooltip, showing the detail of the error. The icon is also followed by its description in the "Extended CAD Status" field. Status display is an operation that on large offers may slow down the normal use of the software, so you can disable this automatic feature and make it manual (look at paragraph **Error! Reference source not found.**): in this case alignment happens only on user's request when a "Reload Grid" is performed
-  • **Block:** Refers to the DWG block associated with this item. If the block has been manually modified and then differs from the original, icon changes symbol to the bottom right (red to blue), to identify the custom DWG block (look at paragraph 2.10)

Drag&Drop: Dragging a line into drawing area, depending on the situation, different commands are launched:

- If an item or accessory is dragged and its quantity in offer is greater, when it is dragged, than quantity present in CAD session, then command to insert item in CAD session is started again, until alignment is achieved in quantities with the offer.
- If an item or accessory having quantities in CAD session greater than quantity of the offer is dragged, the Delete command is started and you are asked to remove the excess blocks from the CAD session.
- If a zone or note is dragged, text with line information is inserted into the drawing area

By right-clicking on an item line, you can go to identify item in the drawing and highlight it, open its details, duplicate it, cut-copy/paste it or delete it

In case of misalignment between design and offer, two new items appear allowing to correct misalignment quickly:

- **Correct CAD:** in this case you consider as correct the offer and then you go to align the design according to what is in offer. When you select it, the iQuoteCAD command line displays the operation required to align the drawing (adding or deleting blocks). You can also do this by drag-and-drop the row within the drawing area.
- **Correct Offer:** consider the drawing as correct and then align the offer, according to what is present in the drawing.

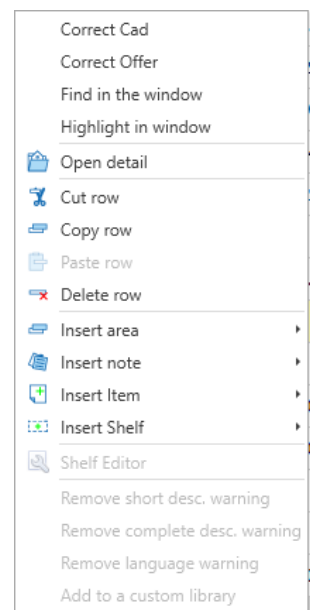

A specific toolbar above the grid makes available a number of service-related utility functions as is the case in iQuoteWin (look at paragraph 1.5). There are also some additional features, not present in iQuoteWin, or slightly different:



✓ The "Delete" command, unlike iQuoteWin, deletes selected row while deleting the quotation line and its DWG block from the iQuoteCAD graphics area. The same function is performed by the "Delete" command in iQuoteCAD: deleting a block from the graphics area automatically deletes the offer line.



↓ The "List of blocks not in offer" command activates if a block DWG not present in the offer is detected in the drawing. Clicking, all those unmatched blocks are shown, and if you select them, you can activate the selection in iQuoteCAD, zoom on them, delete them from the drawing, or try to relink the block to the offer. A typical case in which this command activated is when, after you insert an item in CAD session, iQuoteWin is opened and the line is deleted from the quotation, for example from another user. The CAD has the block in the drawing area and this command is activated.

2.5.1 Item replacement

The command, similarly to what was looked at point 1.5.13, allows the replacement of the CAD block and the offer line with an alternative item chosen from the library or, in the case of replacement of an obsolete item, proposed by the system on the basis of the information received from the manufacturer.

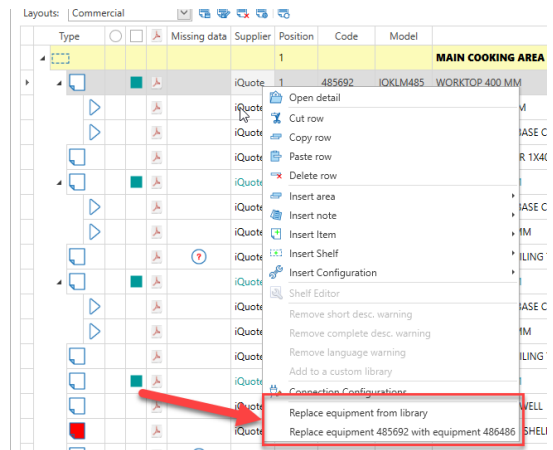

2.6 INSERTING CAD ITEMS

📄 To insert an item from library, select it and click the insert button at the top or, faster, drag-and-drop it into the drawing. Moving through the drawing space, preview of the inserted DWG block appears with the cursor.

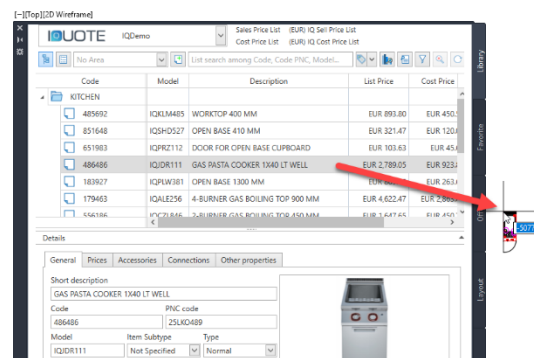

The insertion of an item can also be done with the "Insert by Code" command on the ribbon and which allows a direct insertion by knowing the article code.

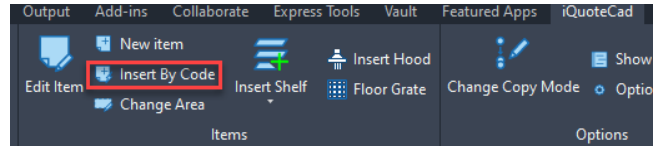

Once in the drawing area, follow the iQuoteCAD command-line instructions, that guiding you to insert. Some indications:

- Each block has a predefined dragging base point, to change it press the Spacebar to use any alternative insertion point.
- Choose the rotation of the block, moving the mouse or typing the degrees and confirming with Enter.
- If you chose to insert an item with quantity greater than 1, you are asked multiple times for the item placement while the request to rotate the blocks after first depends on the setting "Keep accessory position after first insertion" in the options (look at paragraph **Error! Reference source not found.**)
- Behavior when inserting accessories depends on several factors:
 - First of all, if the accessory does not have a CAD block in the library, no operation is required, a "ghost" block (without geometry) is inserted automatically.
 - If the accessory has a CAD block and an insertion point has been pre-assigned in the library, no operation is required, block is automatically placed according to the parent item.
 - If the accessory has a CAD block and there are no additional rules in library, you can place it as a normal item by entering position and rotation. There is also possibility to select one of the following options:
 - **Invisible:** the CAD block is not, inserted but a "ghost" block (without geometry) is automatically placed in its place
 - **basePoint:** only rotation angle is required, while the point is the same as the base point of the parent item.
 - **basepointRotation:** the block is placed in the same point and with the same rotation of the parent item.

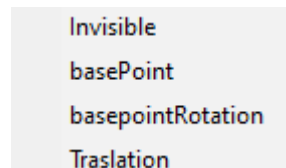

- **Traslation:** Block has the same rotation as parent item, but the point is translated from the parent base point of a specified distance.

After items insertion, you can hover with the mouse over them and, without pressing any button, stopping for one moment movement, item properties are displayed. This feature is toggled using the "Tooltip" command in the options (look at paragraph **Error! Reference source not found.**) or in the iQuoteCAD status bar (look at paragraph 2.2).

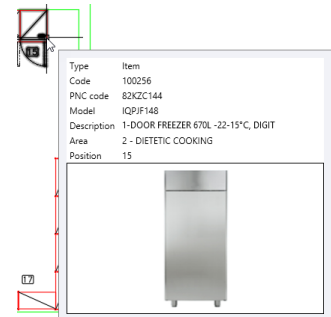

2.6.1 Interaction with AutoCAD commands

iQuoteCAD intercepts all AutoCAD edit commands (e.g., copy, move, rotate, etc ...) keeping offer up to date congruently with the operation performed.

2.7 EDIT ITEM

To edit an already inserted item, you can select it in the graphics area and activate the "Edit Item" palette. You are able to change the various features of the items. If quantity of the item or accessories is changed, after saving, you are prompted to place/delete the blocks DWG, to align quantities in the drawing.

If multiple items are selected in the drawing area, use the menu at the top right of the palette to decide which item to edit. Opening the menu a grid is displayed, where there is also a column, indicating whether item has connections or not. It is possible to filter on this column, in order to have control on all items having connections, in order to proceed, , for example, to data compilation.

Editing an item can also be made by editing the quotation line on its quotation tab, or by right-clicking after selecting an item in the graphics area and running the iQuoteCAD->Edit Item command (look at paragraph 2.9).

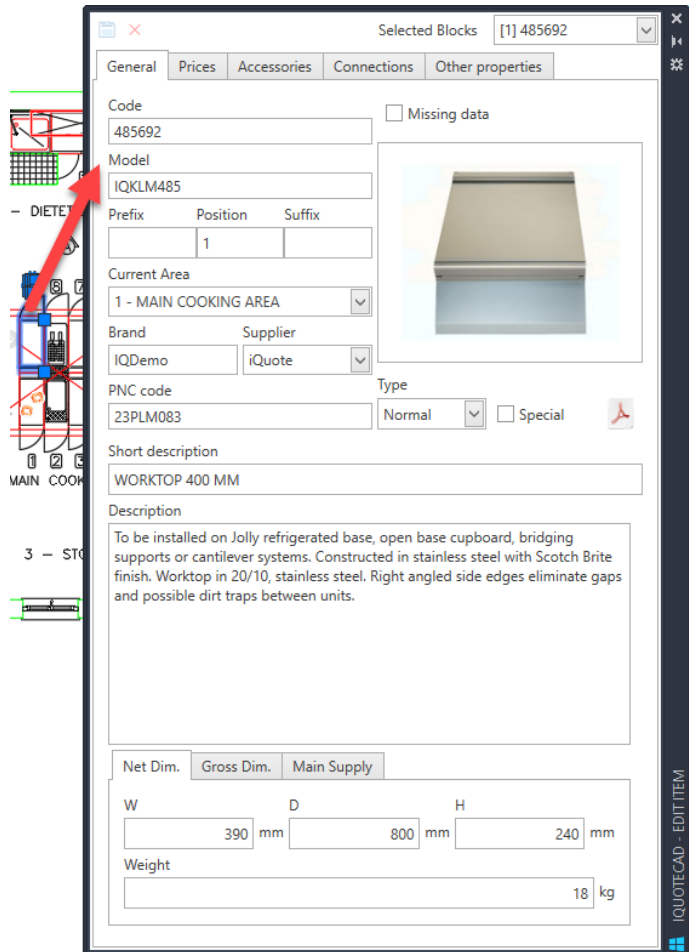

2.8 AREA MANAGEMENT

After selecting a group of items from the graphics area, you can right-click and access the iQuoteCAD->Manage Area menu, so you can move selected items to an existing area or in a new area you can create directly from the command interface.

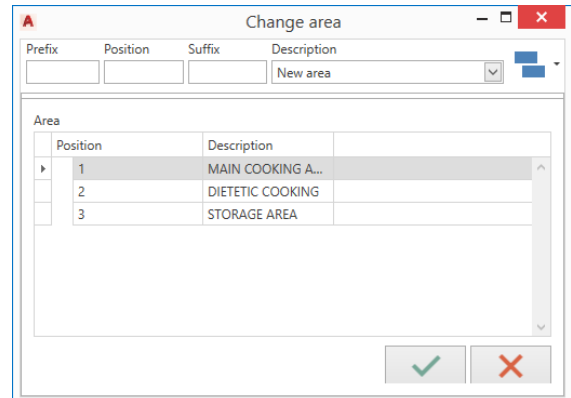

2.9 CONTEXT MENU UTILITY

We have already learned how, after selecting one or more items in graphics area, you can access a context menu with several iQuoteCAD commands.

These include some general features:

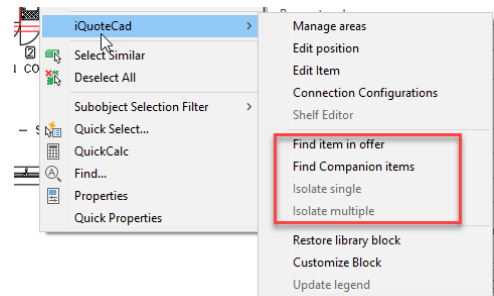

- **Find item in offer:** In iQuoteCAD palette, offer section, row corresponding to the item highlights.
- **Find companion items:** In case of a repeating item (i.e. a single item inserted with quantity > 1), it highlights in the drawing all items belonging to that same row.
- **Isolate Single:** In case of a multiple item (i.e., a single item entered with quantity > 1), it allows you to isolate the individual selected item. If, for example, we have a single item with quantity 3, you get an item with quantity 2 and an item (the one isolated) with quantity 1.
- **Isolate Multiple:** In the case of a multiple item (i.e., a single item entered with quantity > 1), it allows you to isolate the individual blocks. If, for example, we have a single item with quantity 3, you get 3 items with quantity 1.

2.10 SPECIAL OR CUSTOM ITEMS

If you need to edit an existing CAD block, create a special or simply to enhance a representation, simply right-click the block in the drawing area and select "Customize Block". You can do the same from the quotation grid on the iQuoteCAD palette and the command on the ribbon.

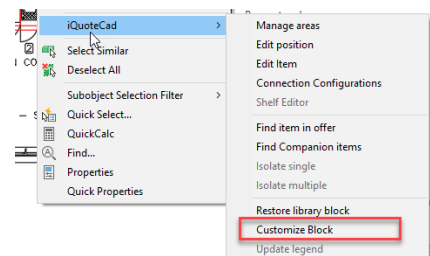

If selected item includes accessories too, you will be asked which item you want to customize among parent and all accessories.

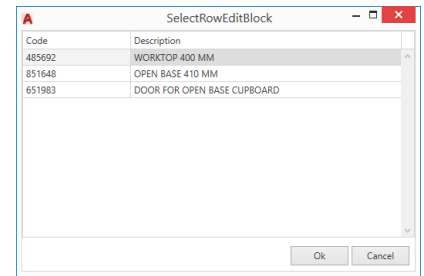

You will then be asked which mode you want to customize block:

- **fromFile:** in this case are prompted to select an existing .DWG file, replacing the original block.
- **Clone:** in this case, current block starts editing using mode set in iQuoteCAD options (look at paragraph **Error! Reference source not found.**) and may be the block editor or direct editing of the block.
- **makeSpecial:** as Clone, but with the addition that quotation row is marked as a special item.
- **selectGeometry:** you can select a geometry from the graphics area and it replaces the existing block definition.
- **Alternativeblocks:** this option is present if certain DWG blocks are foreseen for selected item

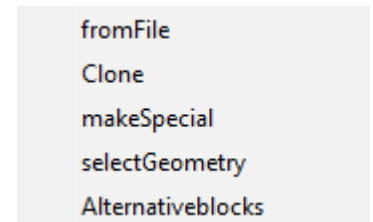

If you have chosen one of the modes involving block editing with iQuoteCAD, you can edit it with the common drawing tools and when you have done you must end command by saving changes (use toolbar activated for this purpose).

At any time, you can return to the original block or add additional changes, by repeating steps described above.

2.11 ITEM NUMBERING

Each item in project has a Position Number property; this property is calculated based on three field present on offer row:

- **Prefix:** can be composed of any alphanumeric character.
- **Position:** can only be composed of numbers.
- **Suffix:** can be composed of any alphanumeric character.

Prefix	Position	Suffix
	1	

The numbering can be done automatically or manually.

First, numbering can be set (1.5.8). If automatic numbering is enabled, nothing needs to be done, software automatically assigns a sequential position number based on the ordering of the rows in offer. Changing the sort order causes an instant and synchronized update of position numbers among CAD and offer. In the event the automatic numbering is disabled, the user can proceed to change the position number in the following ways:

- Starting the edit item command (look at paragraph 2.7)
- Right-clicking on an item in the drawing area and using the "Change Position" command
- Using the Renumber Position the ribbon command. A window appears allowing you to define prefix, suffix, position number style and the starting position of the numerator (optionally you can use utility commands to automatically detect the highest number in offer). Pressing Ok, software asks to select in the desired order, one at a time, items you want to number, to which a sequential number is assigned, starting from the ones chosen. In case in the window you have chosen to enable Constant Numbering, after each assignment software searches, in the same area of selected item, if there are other items with the same identical characteristics and in the case, they are numbered with the same position (in offer rows are merged and quantities are summed)

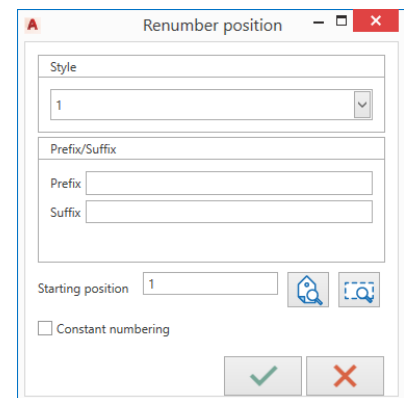
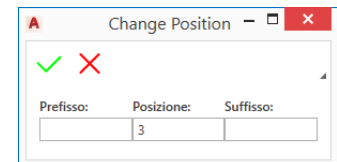

2.11.1 Utility

By using the Align Position command on the ribbon, you can align a group of position numbers. Command requires you to select a group of position numbers (you can select with a window, because only valid entities are automatically filtered), then you are asked for 2 points identifying the imaginary line, on which all selected position numbers. It's also possible to obtain a visual reference with the type of article (existing, special, etc.) using the mapping managed in the options (see point **Error! Reference source not found.**, item related to "InfoPos Text)."

2.12 CONFIGURATORS

Within iQuoteCAD there are some commands making easier to position or design certain elements.



2.12.1 Shelves

Shelf configurator is bootable from the iQuoteCAD ribbon. As a first step, you need to select the brand you want to work with and the depth of the shelves to use.

You can then choose from a table the height/width of the first shelf and the number of shelves. Optionally you can add additional shelves next to the first one by

pressing this button 

The combination of 2 shelves can take place with 3 different modes:

-  • Counterclockwise corner
-  • Aligned with each other
-  • Clockwise corner

If you choose one of the two corner modes, you will need to choose between two different overlay modes:

-  • Mode 1
-  • Mode 2

Pressing Ok you're prompted to indicate a point in the iQuoteCAD graphics area and selected shelves are drawn. In offer a shelf item is generated, having as accessories all shelf components of the (hips, shelves, ...)

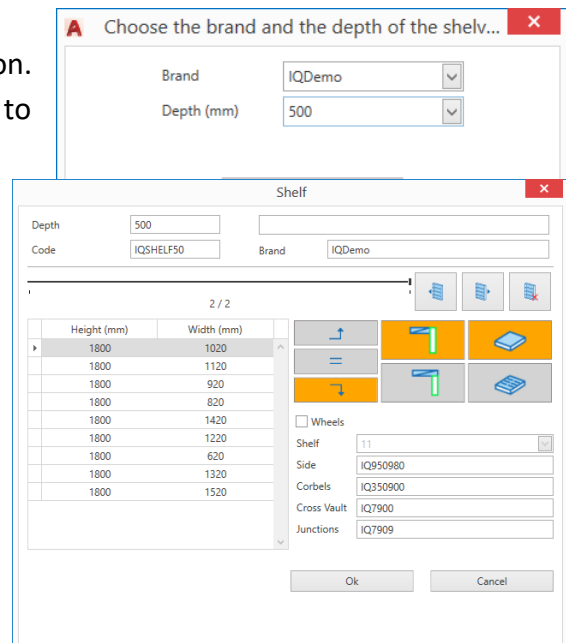

2.12.2 Hoods

This configurator eases the detection of hoods, reflecting certain measurements, or to create a hood with custom measurements. Depending on manufacturer's libraries, there may be several predefined sized hoods in a catalog, or hoods (called custom) that are custom-sold and the size of which fit your design needs. Launching the command (present in the multifunction bar of iQuoteCAD) you are prompted to select 3 points in the graphics area: first 2 must be taken on the front side, third point on the opposite side to detect depth.

A window is then displayed, showing the size of the hood depending on selected points, so you can indicate border margins compared to what is detected (these margins can be set in the options, so that they are automatically re-proposed). Software can automatically detect if you are designing a center hood or a wall hood (if this is not correctly detected, you can change your choice in the upper left corner of the window). Software can automatically detect if you are designing a center hood or a wall hood (if this is not correctly detected, you can change your choice in the upper left corner of the window).

Once you have defined nominal size  of the hood, this button will allow to access the item library, divided by brand. Only items of type "hood" and of the selected type (central or wall) will be visible, and a particular color will indicate hoods fitting to set filters in size (green color), compared to those not meeting conditions (red color). If you confirm configuration window, block for the selected hood is inserted into the drawing area.

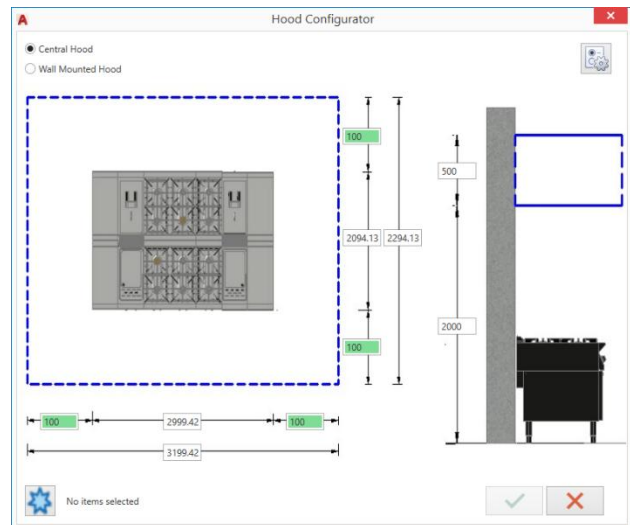

2.12.3 Floor grates

This configurator eases the detection of grids, reflecting certain measurements, or to create a grid with custom measurements. Depending on manufacturer's libraries, there may be several predefined sized grids in a catalog, or grids (called custom) that are custom-sold and the size of which fit your design needs. Launching the command (present in the multifunction bar of iQuoteCAD) you are prompted to select 3 points in the graphics area: first 2 must be taken on the front side (for the wall hoods), third point on the opposite side to detect depth.

A window is then displayed, showing the size of the grid depending on selected points, so you can indicate

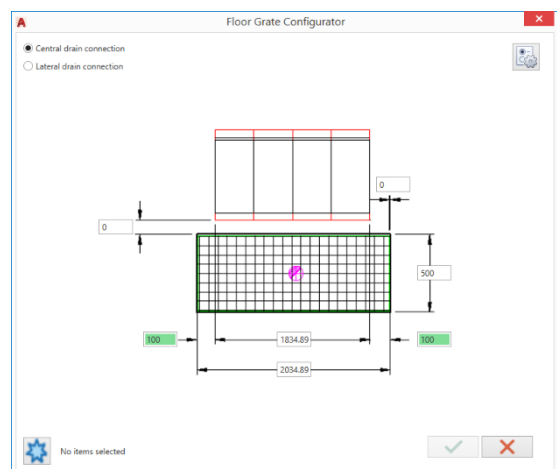

border margins compared to what is detected (these margins can be set in the options so that they are re-proposed automatically).

Once you have defined the nominal size of the grid, this button  will allow to access item library divided by brand. Only items of "floor grates" type and of the selected type (central or lateral discharge) are visible, and a particular color indicates grids reflecting settings set in size (green color), compared to those not meeting conditions (red color).

If you confirm configuration window, grid block is generated in the drawing area.

2.12.4 Cold rooms

This configurator allows you to transform a polyline and insert a cold room in offer.

To begin with it is necessary to draw or identify (if there is already a drawn layout) a closed polyline of straight segments.

At the launch of command we are asked to select the polyline and a point inside it. Once given these two pieces of information a window appears to select settings and the item of the cell itself.

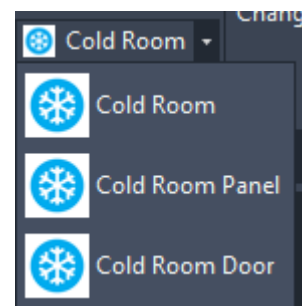

You can indicate:

1. the overall height of the cell;
2. the thickness of the side paneling, ceiling and floor;
3. the width of the panel;
4. the positioning of the cell relative to the floor: if 0 (zero) the cell is resting exactly on the floor.

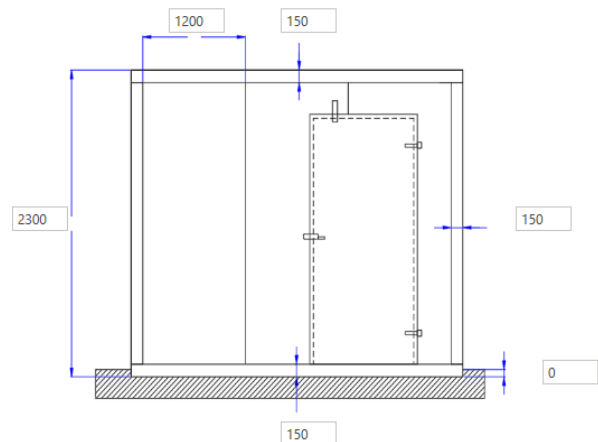

Once you have defined cell graphic information you can access library to select



the desired cell by using the button .

Inside library results are filtered in such a way that there are only cold rooms appropriately identified within the software.



Alternatively, you can request creation of a new item built at the moment.

When the button  is pressed, the item editing window opens (look point 1.5.9), within which you can set the various cell information. Cell size fields are filled in automatically.

Once the selection is finished, accepting the information entered, the program proceeds with the creation of the cell, outlining the specific paneling within the selected polyline.

The "Cold Room – Panel" command allows to insert additional walls inside the cell in order to delimit the spaces inside the cell itself, possibly separating cell into two separate cells. Before proceeding, it is necessary to draw a polyline that defines its path.

When command starts, you are prompted to select the cell and then the drawn polyline; once selection is made, command opens a window for the selection of parameters regarding the thickness of the panels and their width. At the end of command polyline is replaced by the wall drawing with the selected specifications.

The "Cold Room – Door" command allows you to insert one or more access doors to the cell. In this case the door is not seen as an accessory of the cell. When command starts, you are prompted to select a cell wall and, subsequently, an inner point; once this is done, the size of the door (default 1200 mm) is requested and finally the positioning of the same on the previously selected wall; a preview helps in the placement of the door.

2.13 FAVORITES

As seen for iQuoteWin (look at paragraph 1.5.7) iQuoteCAD has a favorite palette too, allowing to create and insert item configurations more quickly. In the CAD environment, you can also store within a favorite the geometric position of the items in space. This happens automatically first time you use a bookmark already created in iQuoteWin: in fact, software asks for each composition item an insertion point and rotation, going to store these information in the same favorite. Next time you insert favorite, you are only asked for insertion point and all items are placed automatically.

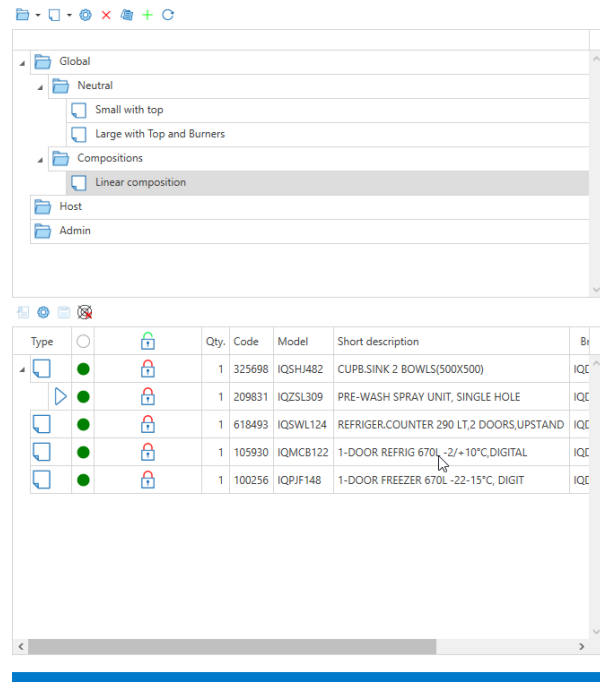

Type			Qty.	Code	Model	Short description
			1	325698	IQSHJ482	CUPB.SINK 2 BOWLS(500X500)
			1	209831	IQZSL309	PRE-WASH SPRAY UNIT, SINGLE HK
			1	618493	IQSWL124	REFRIGER.COUNTER 290 LT,2 DOOR

The presence of the green dot icon next to the items in a favorite means the geometric position in the space has also been stored. If the icon is not present it means favorite has not yet been used in CAD and therefore does

not have the information. Using this icon you can delete geometric positioning information from all rows of the favorite, so you can redefine them. Click on the padlock icon to temporarily unlock the insertion of elements. In practice, elements with the lock open require to be placed manually, even if they already have geometric positioning information.

If you want to create a new favorite directly from CAD, after creating the header of the same with the commands already explained in iQuoteWin, you can use the icon to select a series of items, in the geometric area of iQuoteCAD, and operate so they become automatically the favorite.

2.14 CONNECTIONS SETTING

When inserting items into the drawing area, connections (internal and external) are also automatically added in the form of graphic symbols (see table below). Internal connections (default purple) are those inside the equipment, external (default yellow) are the predispositions that must be made in the environment.

	Electricity		Connection		Interconnection
	Drain		Electricity Derived		Refrigeration in
	Gas		Fumes Outlet		Refrigeration out
	Cold Water		Compressed Air		Inlet coolant
	Hot Water		Condensation		Outlet coolant
	Steam		Decalcified cold water		Chill water in
	Ventilation		Decalcified hot water		Chill water out

External connections are by default placed on top of the inner connection, but you can move around by pressing on the center grip and moving it into the drawing area until you find the correct position for the arrangement.

For each external connection, you can fill in a series of properties (depending on the connection type), in the item editing window. By default, properties of the external connection are valued equal to those of the internal connection. In addition, for each connection, you can set a symbol, allowing to describe the type of predisposition needing to be carried out.

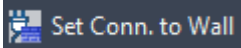
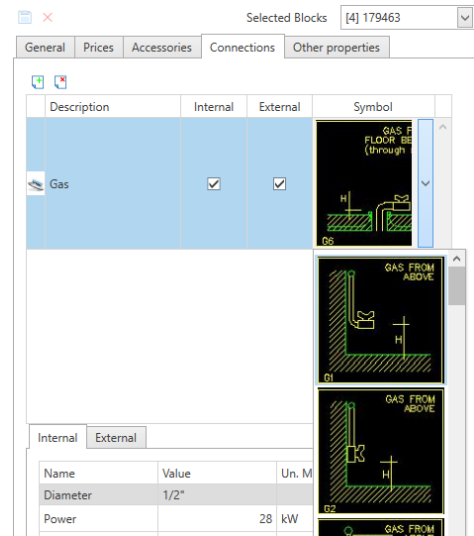

Set Conn. to Wall

A command on the ribbon allows to move all selected outer connections by projecting them onto an imaginary line (such as a wall).

After you configure external connection for an item (properties, symbols, and geometric positioning), you can run the "Connection Configurations" command. The window shows a summary of the current configuration: for each external connection it shows properties, any predisposition symbol and delta x, y, z relative to the insertion point of the equipment. These information can be stored with a name by pressing the Save button, so it can be recalled in the future.

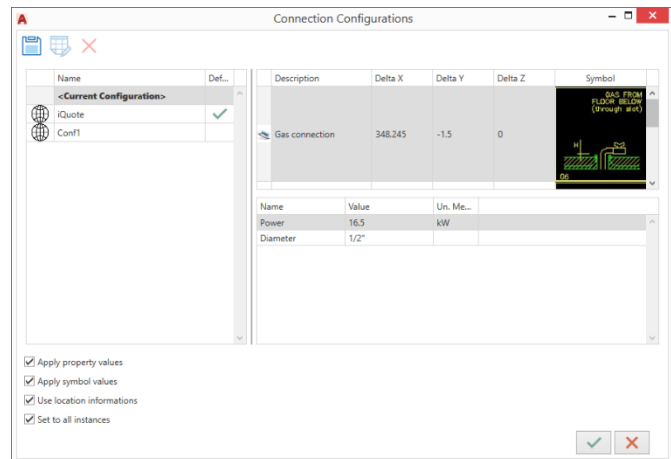

When saving, you can decide shared configuration level (user, workgroup, or global) and whether this configuration is intended as the default.

To use a previously stored configuration, simply run the "Connection Configurations" command, select an existing configuration, and press ok. Before you confirm, you can decide what kind of information to load among properties, symbol, and geometric positioning.

 **Set default conn.** Using this command, you can massively load the connection configuration for an entire project, indicating the names of the configurations to be loaded. You can decide whether to give priority to global or personal default configuration.

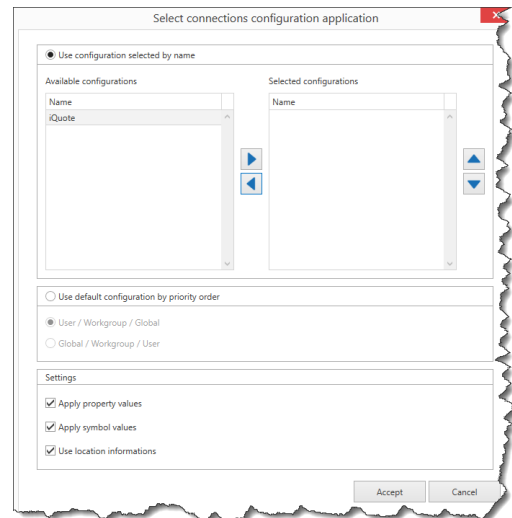

2.14.1 Management of customized connection symbols

iQuotePro administrator can introduce, through the iQuote Administration site explained in next chapters, new connection installation symbols or hide system symbols that are never used.

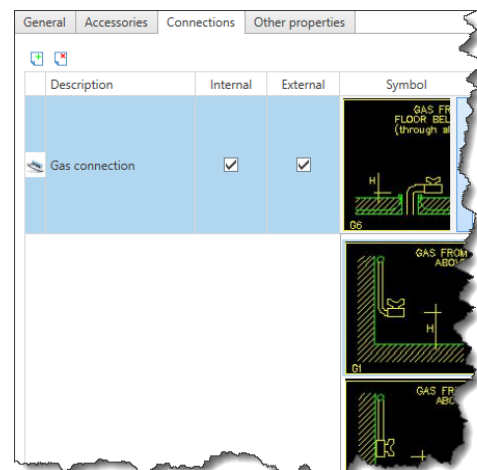

2.15 ITEM LIST

To manage item lists, take to the iQuoteCAD palette and click on the "Offer" tab. The penultimate button above the offer summary gives you access to item list management.

Clicking on the button above, main window appears, divided into two tabs: the first "Full Item List" allows to work on the item list; The second "Synthetic Item List" is dedicated to connection's installation schemes.

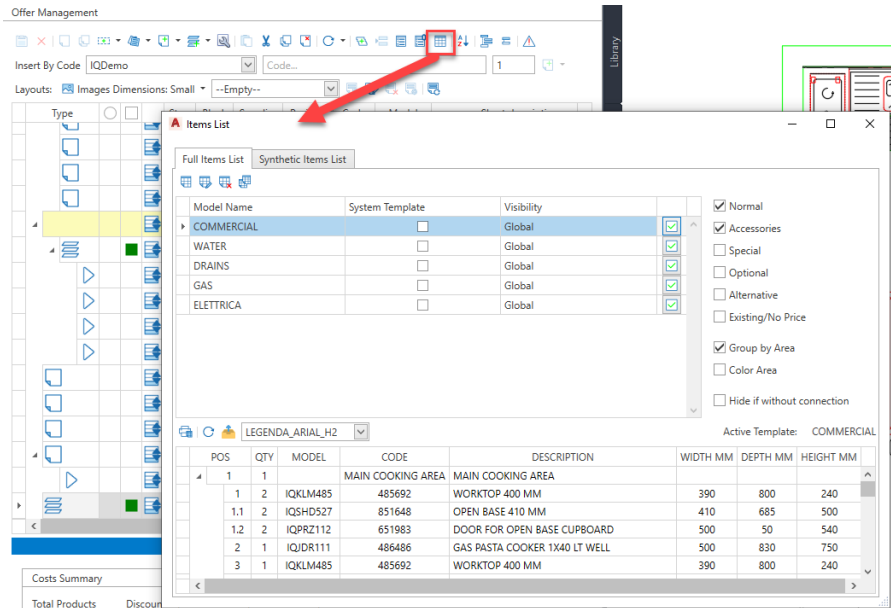

As first step, you have to define one or more item list templates, which are saved in the database and are re-proposed for all projects. Templates allow to define which fields to display in the item list and how they are displayed: they are manageable with the 4 buttons at the top, allowing to add a new template; edit selected template; delete selected template; copy selected template.

2.15.1 Add/Edit Template

Clicking first "Add Template" button takes to the item list style configuration screen.

You can first define the arrangement of item lines among two modes:

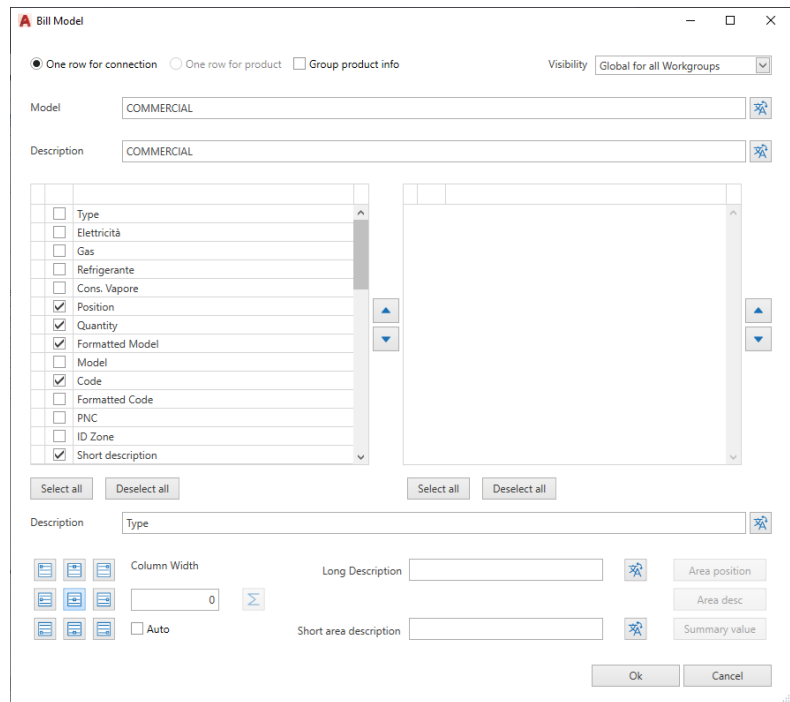

1. One line for connection: If an item contains 3 connections, 3 separate lines are inserted for the item itself, with 3 different connections. In this case you can select "Group product information" to group common item information, such as code, model, size, price etc.
2. One line per item: If an item contains 3 connections, a single line is created and the connections are arranged in the various columns. For this reason, this display mode implies an item list horizontally more developed, an important print assessment.



In the "Model" field, you must enter the name by which to display item list in the list of templates, on the screen explained at the beginning of section 2.15.

In "Description" field, you should specify the item list title being displayed in the first row at the top, when generating/printing item list.

For these fields (and those where the following icon appears)  you can access language management, which means you can enter text in all available languages you want. To do this, click the icon to the right of the field.

 You must then select the fields you want to display in item list, for which you can choose display  order (which in item list will be from left to right), by acting on the appropriate arrows. You can also edit column name by editing the "Description" field below the field list.

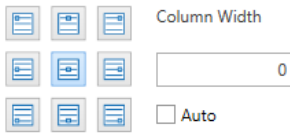

At the bottom of the window, you can define the alignment of the value, displayed in field selected above, and manage its width.

Finally, you can activate summation, useful for example to installers to size the plant, for example on electrical powers. In the "long description" you can define the label of the final total of the item list; in the "short area description" you can define the label of subtotal of each zone.



For both fields, after the label click the "Summary value" button: this adds the text %VAL%, which is replaced by the sum value of the field, when inserting/printing item list.

2.15.2 Items list activation

List contents are displayed at the window bottom by selecting it at the top.

LEGENDA_ARIAL_H2 Active Template: COMMERCIAL

POS	QTY	MODEL	CODE	DESCRIPTION	WIDTH MM	DEPTH MM	HEIGHT MM
1	1			MAIN COOKING AREA			
1	2	IQKLM485	485692	WORKTOP 400 MM	390	800	240
1.1	2	IQSHD527	851648	OPEN BASE 410 MM	410	685	500
1.2	2	IQPRZ112	651983	DOOR FOR OPEN BASE CUPBOARD	500	50	540
2	1	IQJDR111	486486	GAS PASTA COOKER 1X40 LT WELL	500	830	750
3	1	IQKLM485	485692	WORKTOP 400 MM	390	800	240

Using buttons above grid you can:

- switch to print preview (iQuote preview window already explained for offer prints is displayed).
- refresh the view based on changes to models or view filters.
- insert item list into the drawing. Linked to this option is the drop-down menu, which proposes iQuoteCAD table styles (for which management is, therefore, the standard iQuoteCAD one, that is, from the "Annotate->Table Styles" menu).

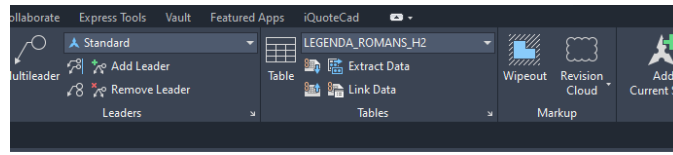

COMMERCIAL							
POS	QTY	MODEL	CODE	DESCRIPTION	WIDTH MM	DEPTH MM	HEIGHT MM
1 - MAIN COOKING AREA							
1	2	IQKLM485	485892	WORKTOP 400 MM	390	800	240
1.1	2	IQSHD627	851848	OPEN BASE 410 MM	410	685	500
1.2	2	IQPRZ112	851983	DOOR FOR OPEN BASE CLPBOARD	500	50	540
2	1	IQJDR111	486488	GAS PASTA COOKER 1X40 LT WELL	500	830	750
3	1	IQKLM485	485892	WORKTOP 400 MM	390	800	240
3.1	3	IQPRZ112	851983	DOOR FOR OPEN BASE CLPBOARD	500	50	540
3.2	1	IQPLW681	183927	OPENBASE 1300 MM	1300	800	700
4	1	IQALE259	179483	4-BURNER GAS BOILING TOP 900 MM	900	700	280
5	1	IQKLM485	485892	WORKTOP 400 MM	390	800	240
5.1	3	IQPRZ112	851983	DOOR FOR OPEN BASE CLPBOARD	500	50	540
5.2	1	IQPLW681	183927	OPENBASE 1300 MM	1300	800	700

2.15.3 Synthetic item list

Synthetic item list automatically searches for all different types of connections in the project, proposing them at the top of the window. By checking marks for desired connections, you can see, at the bottom, all the installation schemes set by the user for the various items of the project. If an installation scheme is repeated for multiple connections in the project, it is automatically grouped: for each scheme, items to which it is associated are indicated, in the format "Areald-Location", as shown in the following example:

<input type="checkbox"/>		Connections
<input type="checkbox"/>		Gas connection
<input type="checkbox"/>		Cold water
<input type="checkbox"/>		Drainage 1

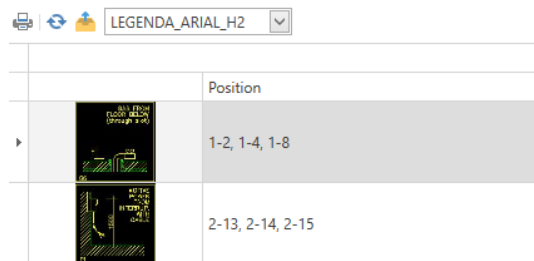

Here too, by clicking on the appropriate icon, you can access print preview or item list insertion in the DWG file, according to selected table style.

2.16 SECTION VIEW

From the ribbon you can start command "Section View": this command requires selection of two points, identifying section line, and a direction, indicating from which side to orient the view (a red line on video helps user in selection).

After the section line selection, a window appears allowing you to vary some options:

- Identifier: Enter a letter to identify section.
- Depth: You can create a complete section, which means from section line view will have infinite depth, or you can specify a distance for section depth (distance can be typed or obtained directly from graphics area).
- Style: You can choose from different types of section symbols being displayed in the center of selected section line and different visualization types (wireframe, hidden, shaded).

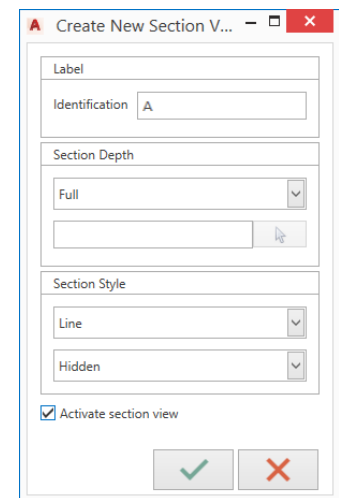

You can also choose whether to activate section immediately or not. In any case, view is stored with name and is available from the drop-down list in iQuoteCAD palette, in layout section (look at paragraph **Error! Reference source not found.**).

2.17 GROUP SELECTION ON/OFF

The command on the ribbon allows the user to change the type of selection from "Group Selection" to "Single Entity Selection" and vice versa, without having to access the AutoCAD options.

2.18 LAYOUT

Layout section is divided into 4 tabs, which can be selected at the top:

2.18.1 Views

- Views – Orientation: a link to the AutoCAD native function, allows to select viewpoint you desire. Command can be used in both iQuoteCAD model space and layouts. In the latter case, when you press the button, you will be prompted to select two points to draw the layout window, within which to create view.
- Views – Camera: allows you to insert a camera indicating 2 points (device point and target point), the height of the two points must be indicated before performing command, as well as the focal amplitude of the lens. View is automatically activated and added to the Views list in the Camera section, so that it can be recalled later or, if used in layout environment, a dedicated window can be created.
- Views – Style: Link to AutoCAD's native function, allows to choose display mode, in wireframe or realistic or conceptual.
- Views – Manage Layer: iQuote custom panel to easily turn on and off layers for blocks inserted by the library and AEC commands, as well as enable/disable 2D and 3D. At the bottom, you can choose the types of connections to display in current view: this allows you to quickly create so-called executives. The layers turning on and off can occur globally, if command is used in AutoCAD Model space, or in layout only affects previously selected window (in case you choose to operate on layouts, it is recommended to turn on all layers in the Model space and then to go to turn off layers not needed only for some layout windows). The Annotation Group drop-down menu is automatically populated with any

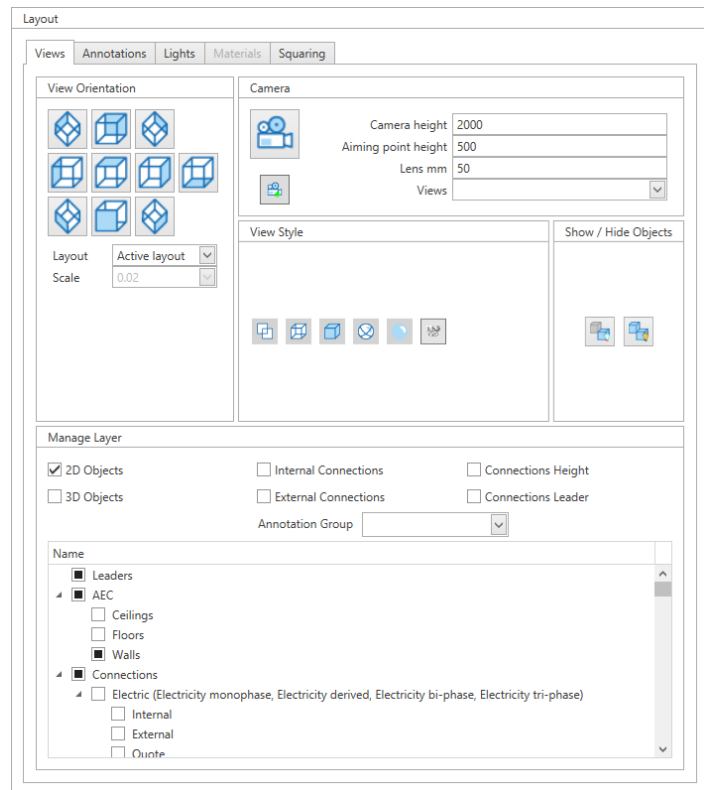

section views created: this allows to act on the turn on/off of the layers related to the specific section view.

2.18.2 Annotations

Commands on the Annotations tab generate geometries (quotas, annotations, ...) on dedicated layers depending on the Annotation Group selected. If nothing is selected, they are generated on the generic layer; if a specific section view is selected, they are generated on layers dedicated to the view.

- **Connection dimensions:** Allows to quickly dimension the connection of the items inserted from library. The connection dimensions always refer to external connections, so they can be considered useful information for installers. For each dimension operation, only one type of connection can be selected, which means that the procedure must be performed for each type of connection desired. Once selected type of connections to be dimensioned and the dimension style (characters and symbols that are inserted and the styles you can select are those of iQuoteCAD and then viewable and editable from the ribbon "Annotate" – "Dimension"), you can choose dimension type:

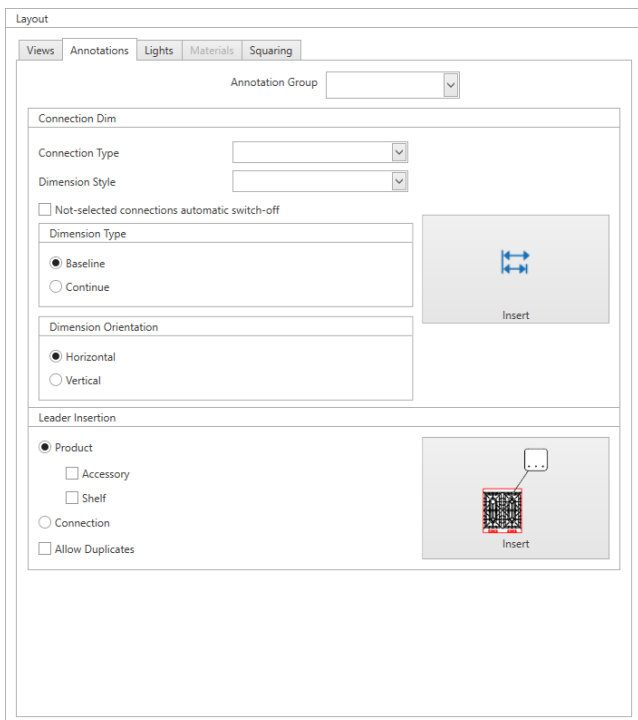

- **Baseline:** Connections are always dimensioned respect to a baseline, chosen by the user.
- **Continues:** first connection is dimensioned from the chosen baseline, subsequent are dimensioned compared to the previous.

Dimension orientation should then be chosen:

- **Horizontal:** Dimensions are calculated and inserted relative to the horizontal axis.
- **Vertical:** Dimensions are calculated and inserted relative to the vertical axis.

Finally, click insert: the iQuoteCAD command line guides the insertion of dimensions, you are prompted to:

1. Select items to include in the dimension: you can click on each item, or select an area with a window. All connections (depending on the type of connection defined) found in the window are considered to be dimensioned.
 2. Select the baseline from which to start dimensions.
 3. Click where you want to view the dimensions.
- Leader Insertion: (ballooning) allows to insert leaders with text at the ends. Selection can be filtered according to the ballooning of items or connections. Text displayed can be customized in iQuoteCAD Options (look at paragraph **Error! Reference source not found.**) You can also decide whether selection allows duplicates or not, this allows to exclude from selection elements (items or connections) already ballooned previously. If the article with its properties has changed or the formatting of the leader has changed from the options (see point **Error! Reference source not found.**, item related to “Open Leader Settings”), you can update the data by pressing the “Update Leaders” button on the ribbon.

2.18.3 Lights

- Group: allows a group of lights to be inserted into the graphics area (typically for lighting a room). You can set the geometry type (only light or light with a ceiling light), ceiling height, distance from the wall, step between lights, and intensity of lights at the edges and center. Once command is executed, 3 points are required to locate the room: first two must be taken on the main side and define length and rotation respect to global coordinates, third on the opposite one, so you similarly define its length. When you've done, you can edit or delete lights individually.
- Single: Allows a single light to be inserted in a selected point.

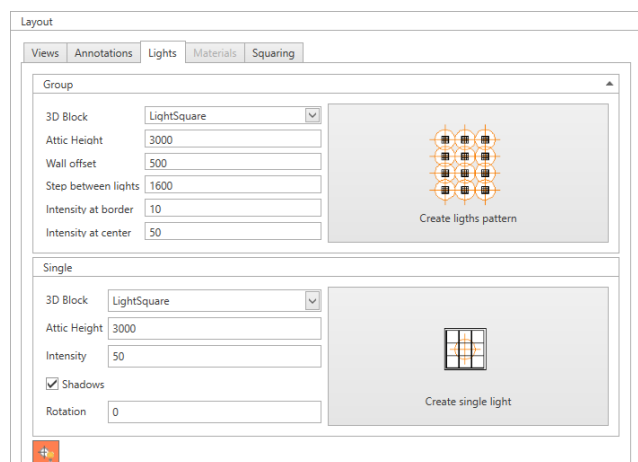

You can change intensity or height values from the ground directly from the palette, selecting one or more existing lights in the graphics area.

2.18.4 Squaring

- **Border:** Select the square and title block to be inserted into paper space. "Adapt" allows to automatically place square and the title block in correct position of the sheet; rotate allows to rotate square in case orientation of the page is different from that of the square.

Squares and title blocks are customizable: they are simple DWG files located in the "CAD Template" path defined in the iQuoteWin options, in the "Frames" subfolder.

You can add and synchronize offer information within the drawing, inserting specific labels, using the AutoCAD command.

Labels recognized by iQuoteCAD are as follows:

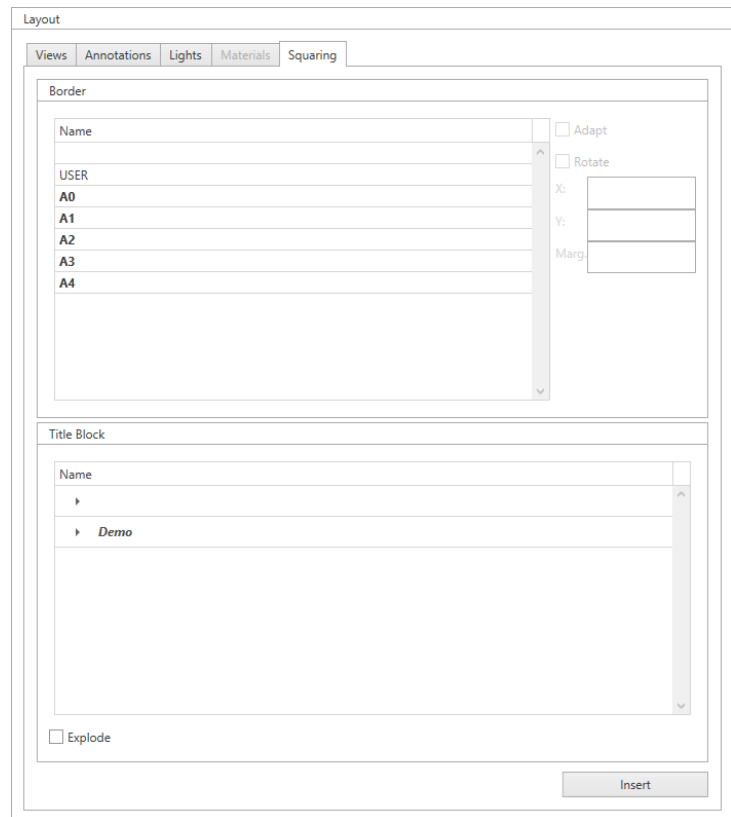

IQ_CUSTOMER_ZIPCODE
 IQ_CUSTOMER_CODE
 IQ_CUSTOMER_FISCALCODE
 IQ_CUSTOMER_EMAIL
 IQ_CUSTOMER_KEYACCOUNTCODE
 IQ_CUSTOMER_PLACE
 IQ_CUSTOMER_COUNTRY
 IQ_CUSTOMER_VATNUMBER
 IQ_CUSTOMER_STATE
 IQ_CUSTOMER_COMPANYNAME
 IQ_CUSTOMER_STATE_SIGN
 IQ_CUSTOMER_FAX
 IQ_CUSTOMER_PHONE
 IQ_CUSTOMER_WEBSITE
 IQ_CUSTOMER_ADDRESS
 IQ_CUSTOMER_HEADER

IQ_CUSTOMER_NAME
 IQ_OFFER_ANNOTATION
 IQ_OFFER_CODE
 IQ_OFFER_CRMID
 IQ_OFFER_CREATIONDATE
 IQ_OFFER_EXPIRATIONDATE
 IQ_OFFER_MODIFICATIONDATE
 IQ_OFFER_DESCRIPTION
 IQ_OFFER_SUBJECT
 IQ_OFFER_REVISION
 IQ_OFFER_DESTINATION
 IQ_OFFER_CREATIONUSER
 IQ_OFFER_MODIFICATIONUSER
 IQ_OFFER_CURRENCY
 IQ_OFFER_VERSION
 IQ_OFFER_SALESMANAGER



2.19 OPTIONS

Within the Standard AutoCAD Options, you can also find the iQuoteCAD options in a dedicated tab.

In the same window we find both options that are stored in the current drawing, and general options that are saved globally. To distinguish them,  simply refer to whether or not the icon  is present, identifying options saved in current drawing.

In detail:

- **AutoCorrect Differences:** Allows software to automatically correct any inconsistencies among drawing and offer (a typical example is position numbers: if this option is enabled, they will be kept aligned without having to manually intervene).
- **Infosop Text:** This is the item position number; in this section you can decide whether to toggle the display of the number, in addition to customize text content (you can compose it by inserting fixed texts and/or variables, such as the area position number, the description of the area and the position number of the item). It is possible to customize the outline of the text by choosing between different formats and the color with which the position number, linked to a specific type of article, must be displayed. If the shape overlaps the drawing you can set a displacement (offset) so that the overlap does not occur.
- **Area Text:** This is the text appearing when you drag an area from the offer tab within the drawing. Text can be customized with fixed values and variable values, such as area position and area description.
- **Formatting:** Allows the choice of font style used for text and the text height in printing (expressed in drawing units and multiplied by the scale factor chosen in the options).
- **Library Tooltip:** Enables display of advanced tooltips when moving mouse over library items (tooltip contains the item image and description).
- **BlockTooltip:** Enables display of advanced tooltips when moving mouse over items in iQuoteCAD graphic area (tooltip contains the item image and description).

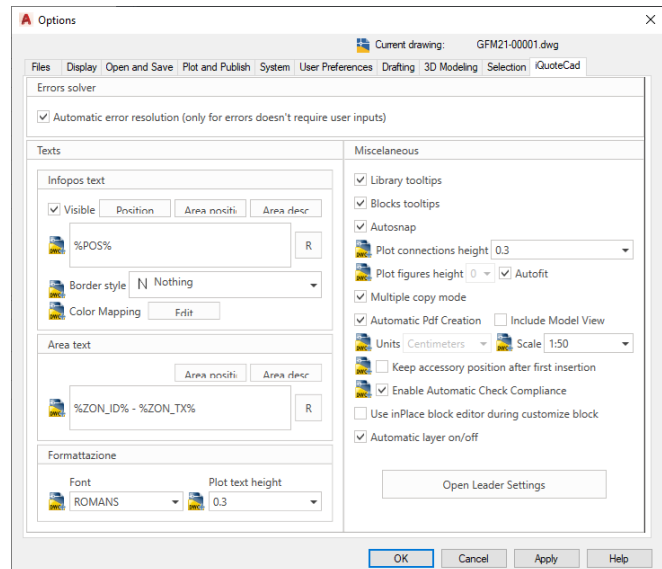

- **Autosnap:** If enabled during item insertion, all object snaps are disabled, leaving only the Node snap active (at the end of the command previously active snaps are restored).
- **Plot connection height:** Sets the height of the inner and outer connection symbols in drawing units multiplied by the scale you set.
- **Plot figures height:** Sets the height of the figurines within the CAD item lists; if the appropriate flag is enabled, they will be automatically sized according to the size of the cell containing them.
- **Multiple copy mode**– If enabled, each time you copy an item within the graphics area, quantity in the quotation is increased. If disabled, each copy creates a new quotation line with quantity 1.
- **Automatic pdf creation**– If enabled, a PDF file is also created when you save the DWG file, to display a preview in iQuoteWin. If “include model view” is also enabled, PDF have also a page dedicated to the template, in addition to layouts.
- **Units**– Sets the units of measurement of the current drawing. The value is editable only when no items have been inserted into the drawing area.
- **Scale:** sets the scale of the drawing, used as a multiplier for the height of texts, symbols, ...
- **Keep accessories position after first insertion:** if active, when an item with quantity greater than 1 and having accessories is inserted, the software requires the placement of the accessories only first time, while for subsequent instances nothing is asked and they are placed similarly to the first. Otherwise, you are prompted to place all the accessories for each instance.
- **Enable automatic check compliance:** If enabled, software automatically update the status of the lines on the offer card, displaying an exclamation point in case of inconsistencies among CAD and offer and a green check mark in case of aligned rows. As this control may require processing time, in particularly "heavy" bids/projects it is recommended to disable it by preferring a manual update “on demand” of the alignment status among offer and CAD.
- **Use in-place block editing during Customize Block:** If enabled, the Customize Block command uses the AutoCAD direct block edit command. If disabled, the block editor command is used. At some times, even though software may have enabled direct editing, it may use the alternative command (this is due to limits currently imposed by Autodesk).
- **Automatic layer on/off:** If enabled, software turns on/off 2D/3D layers depending on selected viewpoint.

- Open Leader Setting:** Selecting this button a window appears to set the style and content of text leaders (balloons). It is possible to differentiatedly customize content of the texts for items and connections, inserting fixed texts and variable texts, taken from the system properties for each type of object. You can also customize the outline style, font, text height and minimum distance the software keeps between balloons and the alignment of the text within the leader.
- Auto apply default connection configuration:** when this option is active, connection configuration, set as automatic default on the item inserted from library, is loaded, including positioning information.

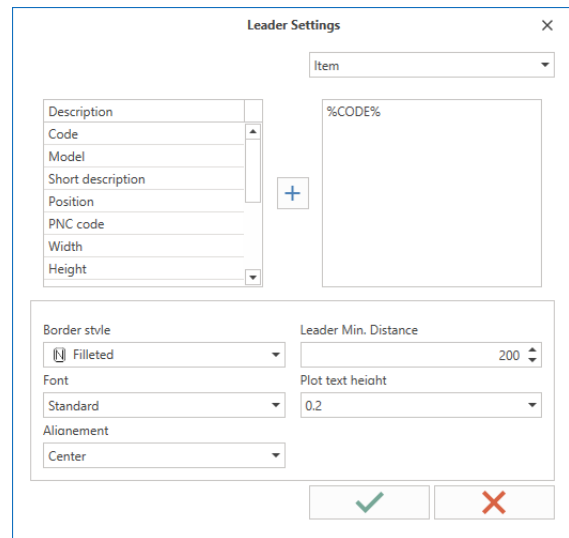

3 IQOTEREVIT

3.1 CREATE REVIT PROJECT FILE

CAD design files are handled as an attachment to the iQuoteWin offer: this structure is required in order to have real-time synchronization between drawing and offer.

To proceed with the creation of the RVT file, you must first create an offer in iQuoteWin, by assigning at least one brand/list as seen in chapter 1.3.1; then, in the details section of the dashboard, go to "attachments" and select "New Project": Revit template file selection window appears.

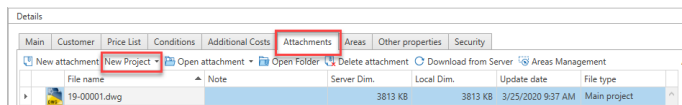

3.1.1 Drawing templates

iQuoteRevit models are Autodesk Revit model files, therefore in standard RVT format:

- By default, 3 system templates are provided and are displayed in bold text in selection window. Any eventual custom templates are displayed in the window with the normal font.
- System templates (shown in bold) should not be modified by the user, this to avoid information loss during iQuote Liveupdate operations (as they would be overwritten).
- You can create additional templates. To do this, create file with your specifications in iQuoteRevit and save it in the RVT format in the path defined for iQuoteRevit templates in the Custom subfolder (path that can be defined in the iQuoteWin options, look at paragraph 1.9)
- By selecting the second "From File" option, you can start the design from an existing RVT file. Starting from an existing file, in addition to the project in the file, you are using drawing settings of the creator of the RVT file too.

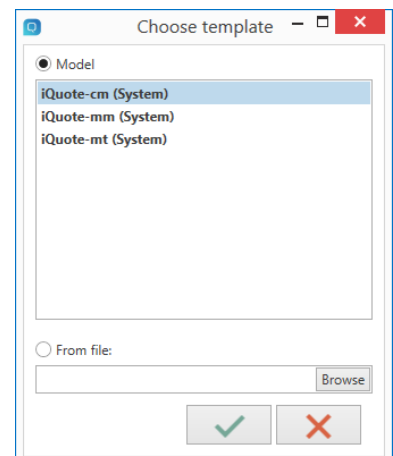

Once you have chosen starting template, confirm and open file by clicking the confirmation button, then click the "Save" command at the top of the multifunction bar.

3.1.2 Multi-RVT creation

iQuote Win allows to manage multiple RVT attachments for the same quotation. Assuming you run a project for a multi-floor restaurant, for example, you might have a unique offer for the whole restaurant, but a specific RVT file for each floor. iQuoteWin works for areas and sub-areas: for example, inserting the two main areas "Plan 1" and "Plan 2", we could define a design for each floor.

First RVT you create is automatically associated with all areas and remain the main one, which means that by opening the RVT file you can interact with all areas of the offer.

From the second RVT file created onwards, you are prompted (together with template choice) to select the areas to link the RVT in creation: select areas to associate it with and confirm, then click "Save". Each area can be associated with only one RVT: so, when an area is assigned to a secondary drawing, it's removed from previous drawing, to which it was linked.

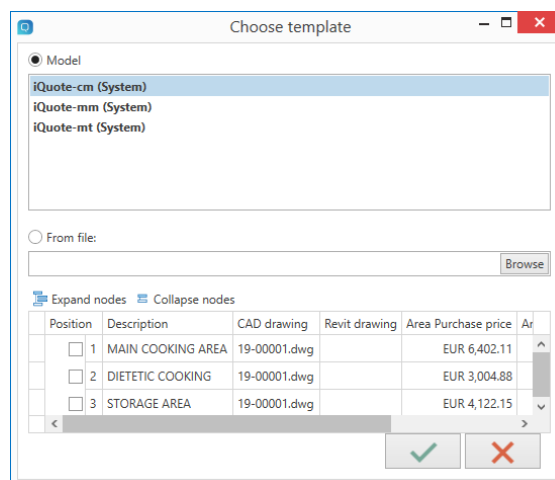

You can change association of a RVT file to areas at any time, although it is recommended to associate areas when they are still free of items, to avoid misalignments or inadvertent data loss.

In iQuoteWin, select main project from the quotes list and go to the Attachments section. Select the RVT file here and click the "Manage Areas" button above: a window appears showing current RVT file association, select/uncheck the areas and click on confirm.

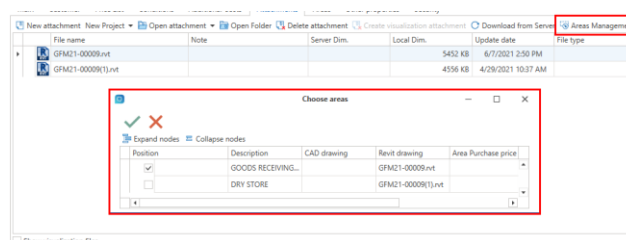

3.1.3 File RVT opening

You can open project attachments for a quotation in two different ways:

- Open the RVT file with a double click, or by selecting it and clicking "Open Attachment" in the Attachments tab in iQuoteWin
- Use the Open Project command on the iQuoteRevit ribbon: quotations in the archive are displayed and, for each of them, project attachments, that can be opened with a double click.

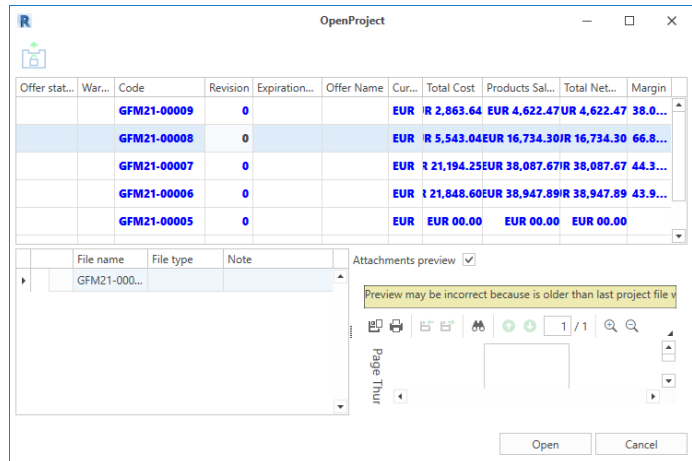

As with iQuoteWin, when you open iQuoteRevit you are prompted for the user's login: login window works the same as iQuoteWin, so refer to paragraph 1.1

3.2 INTERFACE

The interface is the Revit classic, to which iQuoteRevit specific commands are added.

In particular, a new command tab is added to the ribbon and 1 side tool palette.

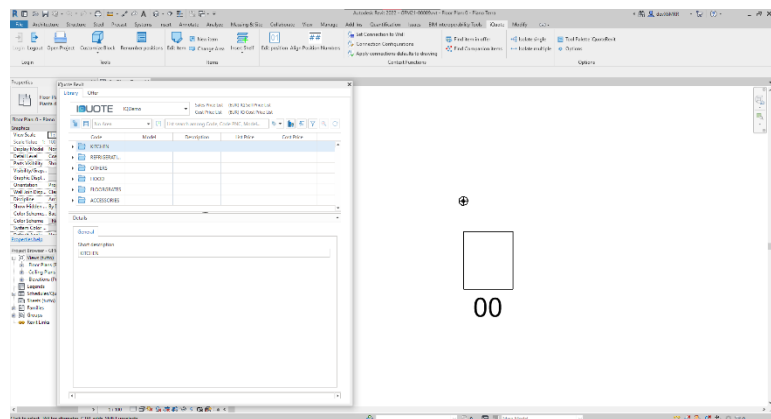



3.3 LIBRARY

Library allows to access library navigation, depending on the marks/lists activated for current offer. Use of the library is the same as seen in iQuoteWin, so refer to 1.5.1 and below. The only exception to iQuoteWin is that when inserting items, you are prompted to indicate a Revit block insertion point (see point 3.5)

3.4 OFFER

The iQuoteRevit software allows a direct synchronization between design and offer. This means that every operation performed in the iQuoteRevit graphics area also affects the offer database directly and then iQuoteWin. You do not need to perform any kind of synchronization operation.

"Offer" tab shows a grid of quotation lines. Compared to the one already analyzed in iQuoteWin, there are some additional columns specific to the Revit environment:

-  • **Move Row:** In the grid, unlike iQuoteWin, you can drag&drop rows to change sort order only by clicking on the navigation icon, not anywhere. This is because the default drag-drop is reserved to insert rows into the drawing area.
-  • **Extended Revit Status and Status:** From these columns you can see if the drawing and offer are aligned. There are two possible icons: the green one indicates item is aligned; conversely, the red icon identifies a misalignment. To know the reason for the misalignment, you can stay a few moments with the mouse on the icon to display a tooltip, showing the detail of the error. The icon is also followed by its description in the "Extended Revit Status" field. Status display is an operation that on large offers may slow down the normal use of the software, so you can disable this automatic feature and make it manual (see point **Error! Reference source not found.**): in this case alignment happens only on user's request when a "Reload Grid" is performed.
-  • **Data Status:** in addition to checking the existence of the equipment within the project, it is verified that some of the basic properties of the article are synchronized between the drawing and the offer (code, model, description and dimensions of the article).



- **Block:** Refers to the RFA block associated with this item. If the block has been manually modified and then differs from the original, icon changes symbol to the bottom right (red to blue), to identify the custom RFA block (see point 3.8)

Drag&Drop: Dragging a line into drawing area, depending on the situation, different commands are launched:

- If an item or accessory is dragged and its quantity in offer is greater, when it is dragged, than quantity present in Revit session, then command to insert item in Revit session is started again, until alignment is achieved in quantities with the offer.
- If an item or accessory having quantities in Revit session greater than quantity of the offer is dragged, the Delete command is started and you are asked to remove the excess blocks from the Revit session.
- If a zone or note is dragged, text with line information is inserted into the drawing area

By right-clicking on an item line, you can go to identify item in the drawing and highlight it, open its details, duplicate it, cut-copy/paste it or delete it

In case of misalignment between design and offer, two new items appear allowing to correct misalignment quickly:

- **Correct Revit Parameters:** allow you to synchronize the data on the offer saving them on the related block; if the item is present for multiple offer rows, you are asked if you want to update all the instances, causing the associated rows to be updated.
- **Correct Offer Row Data:** allows you to synchronize the data on the block saving them on the offer row; if the article is present for several rows, you are asked if you want to update all the rows, as the parameters of the instances are in common.

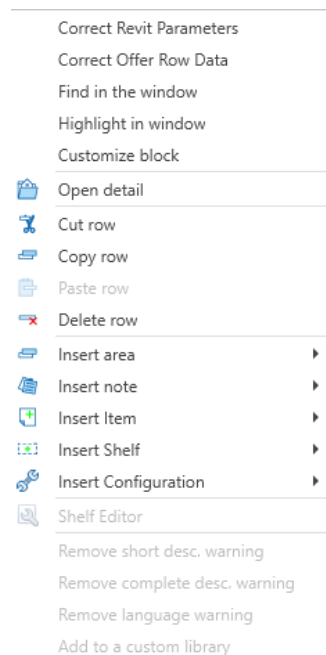

- **Correct Revit:** in this case you consider as correct the offer and then you go to align the design according to what is in offer. When you select it, the iQuoteRevit command line displays the operation required to align the drawing (adding or deleting blocks). You can also do this by drag-and-drop the row within the drawing area.
- **Correct Offer:** consider the drawing as correct and then align the offer, according to what is present in the drawing.

A specific toolbar above the grid makes available a number of service-related utility functions as is the case in iQuoteWin (look at paragraph 1.5). There are also some additional features, not present in iQuoteWin, or slightly different:

 The "Delete" command, unlike iQuoteWin, deletes selected row while deleting the quotation line and its RFA block from the iQuoteRevit graphics area. The same function is performed by the "Delete" command in iQuoteRevit: deleting a block from the graphics area automatically deletes the offer line.

 The "List of blocks not in offer" command activates if a block RFA not present in the offer is detected in the drawing. Clicking, all those unmatched blocks are shown, and if you select them, you can activate the selection in iQuoteRevit, zoom on them, delete them from the drawing, or try to relink the block to the offer. A typical case in which this command activated is when, after you insert an item in Revit session, iQuoteWin is opened and the line is deleted from the quotation, for example from another user. The Revit has the block in the drawing area and this command is activated.

3.4.1 Item replacement

The command, similarly to what was looked at point 1.5.13, allows the replacement of the Revit family and the offer line with an alternative item chosen from the library or, in the case of replacement of an obsolete item, proposed by the system on the basis of the information received from the manufacturer.

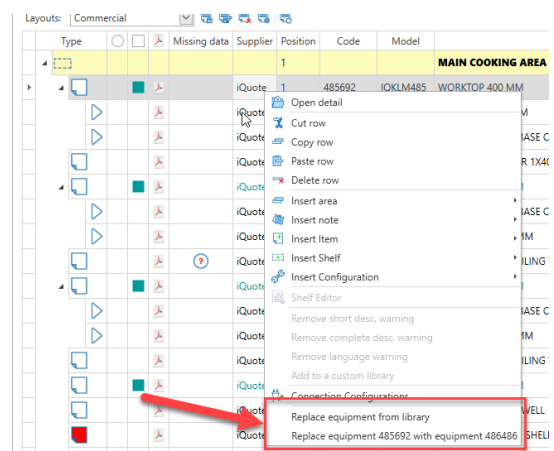

3.5 INSERTING REVIT ITEMS

To insert an item from library, select it and click the insert button at the top or, faster, drag-and-drop it into the drawing. Moving through the drawing space, preview of the inserted RFA block appears with the cursor.

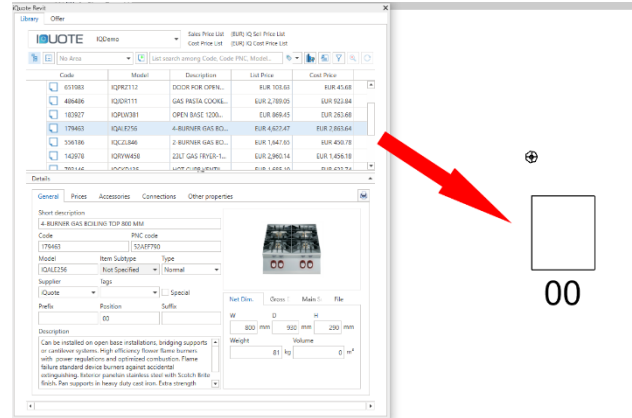

Once in the drawing area, follow the iQuoteRevit instructions, that guiding you to insert. Some indications:

- If you chose to insert an item with quantity greater than 1, you are asked multiple times for the item placement while the request to rotate the blocks after first insertion depends on the setting "Keep accessory position after first insertion" in the options (see point **Error! Reference source not found.**).
- Behavior when inserting accessories depends on several factors:
 - First of all, if the accessory does not have a Revit block in the library, no operation is required, a "ghost" block (without geometry) is inserted automatically.
 - If the accessory has a Revit block and an insertion point has been pre-assigned in the library, no operation is required, block is automatically placed according to the parent item.
 - If the accessory has a Revit block and there are no additional rules in library, you can place it as a normal item by entering position and rotation. There is also possibility to select one of the following options:
 - **Invisible:** the CAD block is not, inserted but a "ghost" block (without geometry) is automatically placed in its place
 - **basePoint:** only rotation angle is required, while the point is the same as the base point of the parent item.
 - **basepointRotation:** the block is placed in the same point and with the same rotation of the parent item.

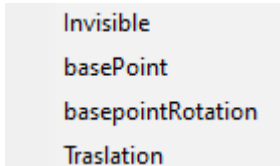

- **Traslation:** Block has the same rotation as parent item, but the point is translated from the parent base point of a specified distance.

3.5.1 Interaction with Revit commands of iQuoteRevit

iQuoteRevit intercepts all Revit edit commands (e.g., copy, move, rotate, etc ...) keeping offer up to date congruently with the operation performed.

3.6 EDIT ITEM

To edit an already inserted item, you can select it in the graphics area and activate the "Edit Item" in the ribbon bar. You are able to change the various features of the items. If quantity of the item or accessories is changed, after saving, you are prompted to place/delete the blocks RFA, to align quantities in the drawing.

Editing an item can also be made by editing the quotation row on its quotation tab.

3.7 AREA MANAGEMENT

After selecting a group of items from the graphics area, you can right-click and access the iQuote->Manage Area menu, so you can move selected items to an existing area or in a new area you can create directly from the command interface.

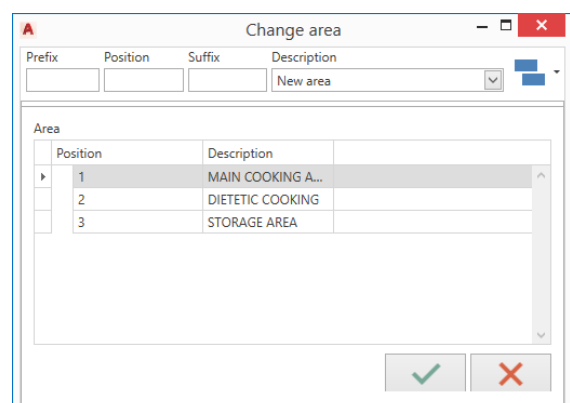

3.8 SPECIAL OR CUSTOM ITEMS

If you need to edit an existing Revit block, to create a special or simply to enhance a representation, simply press the “Customize Block” button in the ribbon: we will be asked which block we want to modify; it is also possible to proceed from the drawing by selecting the block and then the command. The same operation can be done from the offer grid present in the iQuoteRevit palette.

If selected item includes accessories too, you will be asked which item you want to customize among parent and all accessories.

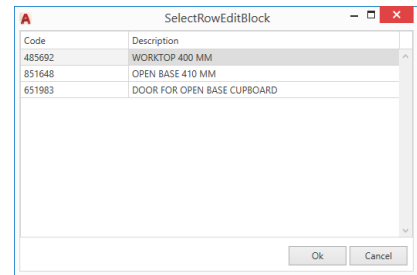

You will then be asked which mode you want to customize block:

- **fromFile:** in this case are prompted to select an existing RFA file, replacing the original block.
- **Clone:** this case the modification of the current block is started, using the Revit block editor.
- **makeSpecial:** as Clone, but with the addition that quotation row is marked as a special item.

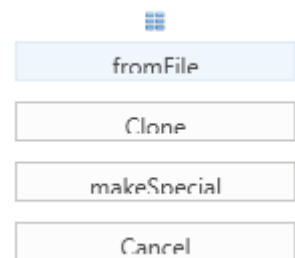

If you have chosen one of the modes involving block editing with iQuoteRevit, you can edit it with the common drawing tools and when you have done you must end command by saving changes (use toolbar activated for this purpose).

At any time, you can return to the original block (selecting “Restore block”) or add additional changes, by repeating steps described above.

3.9 ITEM NUMBERING

Each item in project has a Position Number property; this property is calculated based on three field present on offer row:

- **Prefix:** can be composed of any alphanumeric character.

Prefix	Position	Suffix
	1	

- **Position:** can only be composed of numbers.
- **Suffix:** can be composed of any alphanumeric character.

You can fill position number in a variety of ways.

First, numbering can be set (1.5.8). If automatic numbering is enabled, nothing needs to be done, software automatically assigns a sequential position number based on the ordering of the rows in offer. Changing the sort order causes an instant and synchronized update of position numbers among CAD and offer. If manual numbering is enabled, you can set position number in different ways:

- Starting the edit item command (see point 3.6)
- Right-clicking on an item in the drawing area and using the "Change Position" command

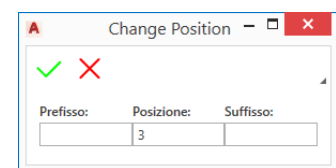

- Using the Renumber Position the ribbon command. A window appears allowing you to define prefix, suffix, position number style and the starting position of the numerator (optionally you can use utility commands to automatically detect the highest number in offer). Pressing Ok, software asks to select in the desired order, one at a time, items you want to number, to which a sequential number is assigned, starting from the ones chosen. In case in the window you have chosen to enable Constant Numbering, after each assignment software searches, in the same area of selected item, if there are other items with the same identical characteristics and in the case, they are numbered with the same position (in offer rows are merged and quantities are summed)

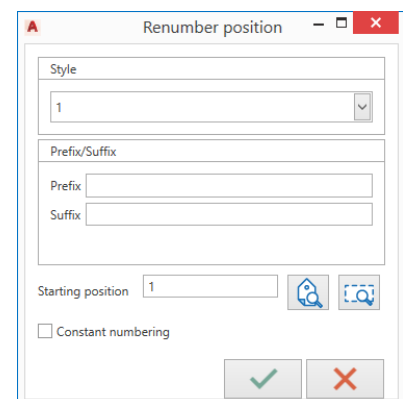

3.9.1 Utility

- By using the Align Position command on the ribbon, you can align a group of position numbers. Command requires you to select a group of position numbers (you can select with a window, because only valid entities are automatically filtered), then you are asked for 2 points identifying the imaginary line, on which all selected position number align.

3.10 CONFIGURATORS

Within iQuoteRevit there are some commands making easier to position or design certain elements.

3.10.1 Shelves

Shelf configurator is bootable from the iQuoteRevit ribbon. As a first step, you need to select the brand you want to work with and the depth of the shelves to use. You can then choose from a table the height/width of the first shelf and the number of shelves. Optionally you can add additional shelves next to the first one by



pressing this button

The combination of 2 shelves can take place with 3 different modes:

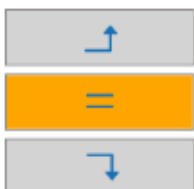

- Counterclockwise corner
- Aligned with each other
- Clockwise corner

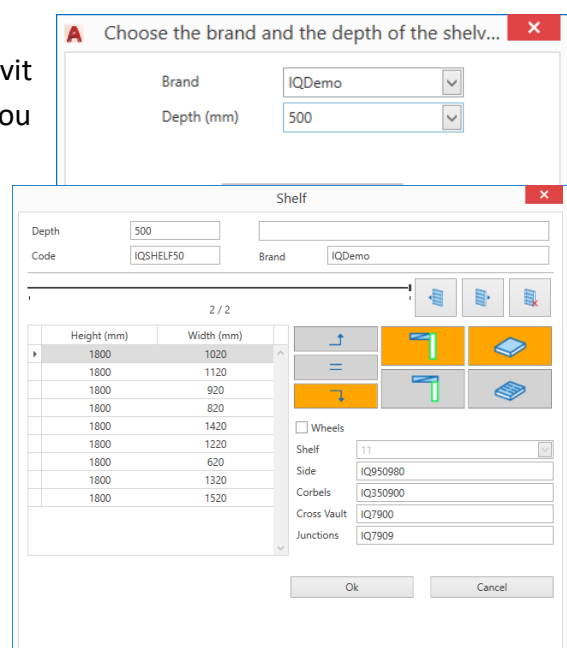

If you choose one of the two corner modes, you will need to choose between two different overlay modes:



- Mode 1
- Mode 2

Pressing Ok you're prompted to indicate a point in the iQuoteRevit graphics area and selected shelves are drawn. In offer a shelf item is generated, having as accessories all shelf components of the (hips, shelves, ...).

3.11 CONNECTIONS SETTING

When inserting items into the drawing area, connections (internal and external) are also automatically added in the form of graphic symbols (see table below). Internal connections (default purple) are those inside the equipment, external (default yellow) are the predispositions that must be made in the environment.

	Electricity		Connection		Interconnection
	Drain		Electricity Derived		Refrigeration in
	Gas		Fumes Outlet		Refrigeration out
	Cold Water		Compressed Air		Inlet coolant
	Hot Water		Condensation		Outlet coolant
	Steam		Decalcified cold water		Chill water in
	Ventilation		Decalcified hot water		Chill water out

External connections are by default placed on top of the inner connection, but you can move around by pressing on the center grip and moving it into the drawing area until you find the correct position for the arrangement.

For each external connection, you can fill in a series of properties (depending on the connection type), in the item editing window. By default, properties of the external connection are valued equal to those of the internal connection. In addition, for each connection, you can set a symbol, allowing to describe the type of predisposition needing to be carried out.

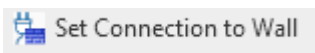
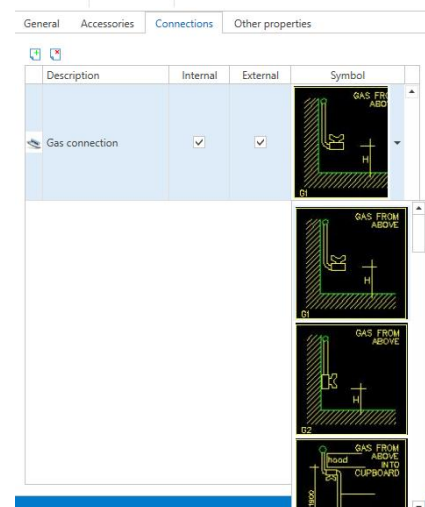

Set Connection to Wall A command on the ribbon allows to move all selected outer connections by projecting them onto an imaginary line (such as a wall).

After you configure external connection for an item (properties, symbols, and geometric positioning), you can run the "Connection Configurations" command. The window shows a summary of the current configuration: for each external connection it shows properties, any predisposition symbol and delta x, y, z relative to the insertion point of the equipment. These information can be stored with a name by pressing the Save button, so it can be recalled in the future.

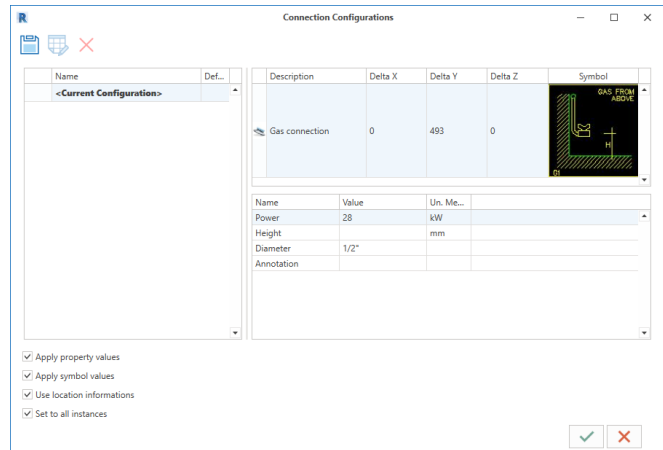

When saving, you can decide shared configuration level (user, workgroup, or global) and whether this configuration is intended as the default.

To use a previously stored configuration, simply run the "Connection Configurations" command, select an existing configuration, and press ok. Before you confirm, you can decide what kind of information to load among properties, symbol, and geometric positioning.

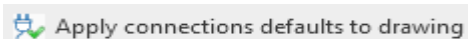

Using this command, you can automatically load the default configuration for all items in the drawing. You can decide whether to give priority to global or personal default configuration.

3.12 ITEMS LIST

The "Item List" command of iQuote Revit integrates the "Schedule/Quantity" command into Revit, making it easy to enter the desired fields within the schedule.

Access to the "Item List" command is from the "Offer" tab using the appropriate button().

At command launch we find template selection window.

At top we find commands for creating, editing, deleting and duplicating selected template,

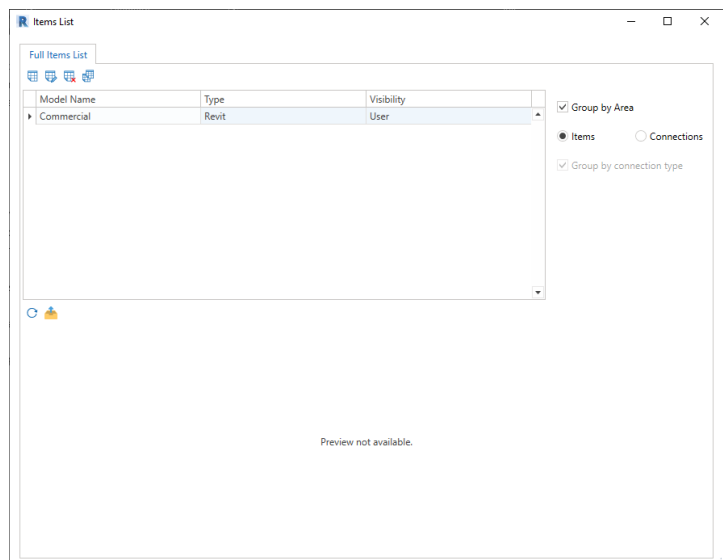

while in sidebar there are visibility and grouping selectors of list rows.

At the bottom we do not find a preview, but only the print and export buttons in Revit.

3.12.1 Add/Edit template

Clicking on the first "Add Template" button takes you to the legend style configuration screen.

Only one display mode is available:

1. One line per connection: if an item contains 3 connections, 3 separate lines are inserted for the article itself, with the 3 different connections.

In the "Model" field you have to indicate the name you want to display the legend in the list of models, in the screen seen at the beginning of section 3.12 **Error! Reference source not found..**

In the "Description" field, title of the legend must be indicated, which is displayed in the first line at the top, during the generation/printing of the legend.

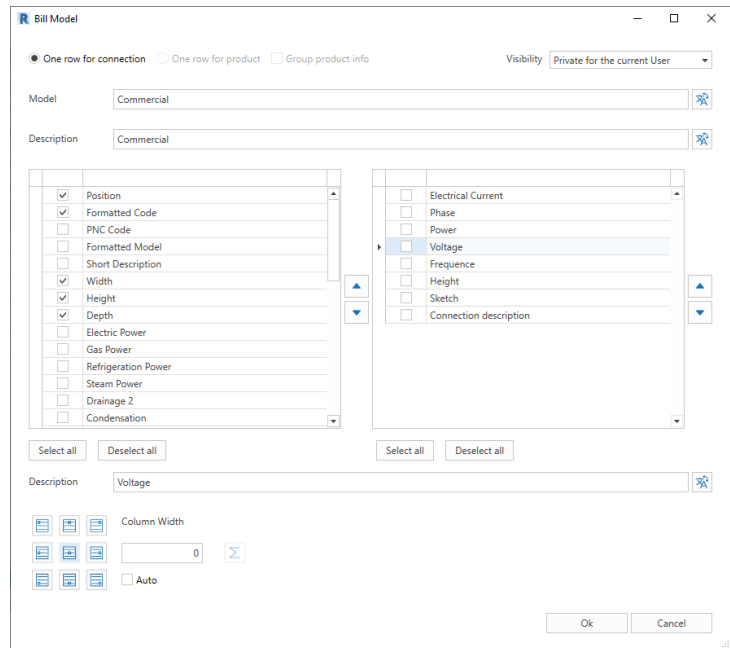

For these fields (and for those in which the following icon  appears) you can access the language management, to enter text in all the available languages you want. To do this, click on the icon to the right of the field.

You must then select fields you want to display in legend, for which you can choose display order (which in legend will be from left to right), acting on the appropriate arrows .

You can also edit the column name by editing the "Description" field below the field list.

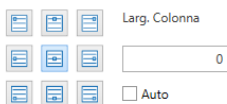

In the lower part of the window you can define the alignment of the value, displayed in the field selected above, and manage its width.

Finally, it is possible to activate the summation, useful for example to installers to size the system, for example on electrical powers.

3.12.2 Items list activation

By selecting model, it is automatically available for the insertion into Revit.

As mentioned earlier, preview is not available.

With buttons placed under the model selection, you can:

- Reload list data;
- insert the list in the Revit project.
When the list is included in the project, a check is carried out in order to avoid duplicates of the list itself. Once the presence of an existing list is detected, in fact it is asked whether to overwrite it or create a new one: in the second case a new list is created, followed by a progressive.

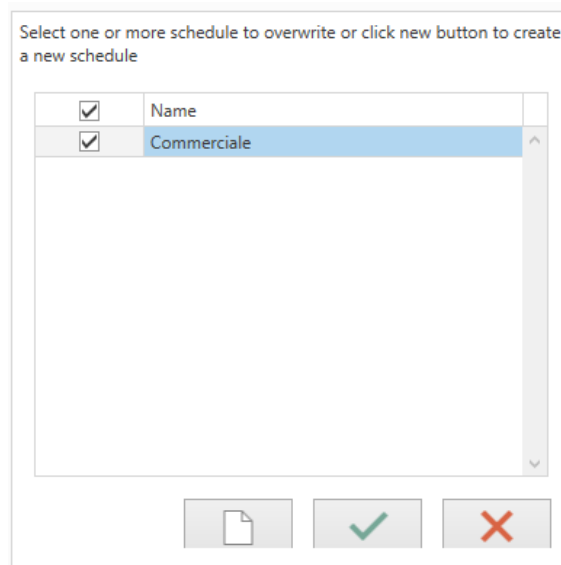

Once command is finished, the Revit window opens with the newly created schedule with the list of drawing items.

N.B.: only items actually present in drawing appear in items list.

<Commercial>				
A	B	C	D	E
Position	Formatted Code	Width	Height	Depth
00	486486	400	956	930

3.13 OPTIONS

The iQuoteRevit options window is separate from the standard Revit options window.

In the same window we find both options that are stored in the current drawing, and general options that are saved globally. To distinguish them, simply refer to whether or not the icon () is present, identifying options saved in current drawing.

In detail:

- **AutoCorrect Differences:** Allows software to automatically correct any inconsistencies among drawing and offer (a typical example is position numbers: if this option is enabled, they will be kept aligned without having to manually intervene).
- **Area Text:** This is the text appearing when you drag an area from the offer tab within the drawing. Text can be customized with fixed values and variable values, such as area position and area description.
- **Multiple copy mode:** If enabled, each time you copy an item within the graphics area, quantity in the quotation is increased. If disabled, each copy creates a new quotation line with quantity 1.
- **Automatic pdf creation:** If enabled, a PDF file is also created when you save the DWG file, to display a preview in iQuoteWin. If “include model view” is also enabled, PDF have also a page dedicated to the template, in addition to layouts.
- **Units:** Sets the units of measurement of the current drawing. The value is editable only when no items have been inserted into the drawing area.
- **Scale:** sets the scale of the drawing, used as a multiplier for the height of texts, symbols, ...
- **Keep accessories position after first insertion:** if active, when an item with quantity greater than 1 and having accessories is inserted, the software requires the placement of the accessories only first time, while for subsequent instances nothing is asked and they are placed similarly to the first. Otherwise, you are prompted to place all the accessories for each instance.
- **Enable automatic check compliance:** If enabled, software automatically update the status of the lines on the offer card, displaying an exclamation point in case of inconsistencies among CAD and offer and a green check mark in case of aligned rows. As this control may

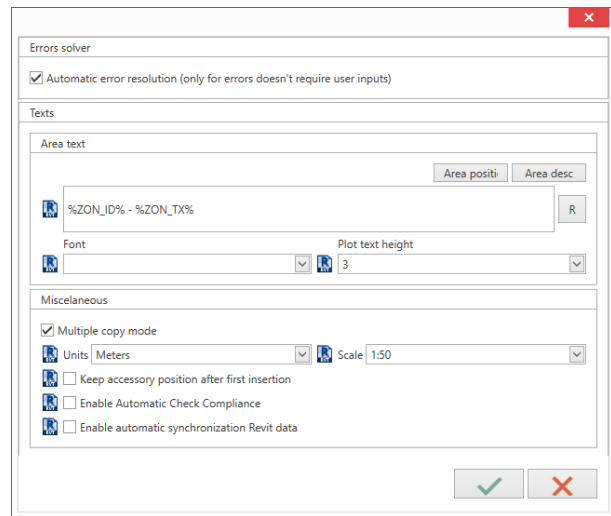

require processing time, in particularly "heavy" bids/projects it is recommended to disable it by preferring a manual update "on demand" of the alignment status among offer and CAD.

4 IQUOTE BACKOFFICE

4.1 IQUOTE MANAGEMENT SERVER

iQuote Management Server is the software configuration management tool, reserved for the installation administrator.

WARNING: Incorrect setting configuration may affect the operation of iQuote, change settings carefully.

To access admin panel, you can:

1. On the server machine, clicking Start→Programs→Apice Consulting→iQuote Management Server; the default browser opens at <http://localhost/iQuote/Account/Login.aspx>

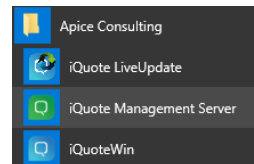

2. From any client, opening browser and entering the <http://localhost/iQuote/Account/Login.aspx>
3. From the iQuoteWin program, pressing icon at the top right, just below the ribbon.

Login page opens: enter login and password of the administrator user (default data are Admin / password) and click on the red "Administration" button. Filling the "Workgroup" field, you can access the administration site as a Workgroup administrator, where you can change settings relating to the selected group. In order to access the administration site as a Workgroup administrator, it is necessary to have the right of Tenant Administrator ("AT") or Workgroup Administrator ("AW"), which can be set on the "Permissions - Users" page (look at paragraph 4.1.2).



The Workgroup administrator is allowed to enable or disable access to the workgroup for already existing users, assigning custom roles for the Workgroup. He can enable and disable price lists present in the server. Finally, he can edit, hide or make visible sale terms available for his group.

4.1.1 Statistics

In the "Statistics" section, you can view some information about size of the database and offer account, in addition to some data about the number of users linked.

Statistics	
Database Dimension	8773.19 MB
Projects Archive Dimension	293.8 MB
Average Offers Version	1.00
Max Offers Version	1
Offers Quantity	2
User Connected to Server	1
Connected User Today	1
Current Accesses	171
Daily Accesses	3

4.1.2 Permissions (Users, Roles, Workgroups)

Users

In "Users" section, you can create access logins to software. For each user, you can set the various read/write permissions on iQuote operations (although it is recommended not to set them at this stage, but in the workgroups section). When user is created, an email is sent to the address indicated (marked for this as a mandatory data), with a temporary password, that user can change at first access.

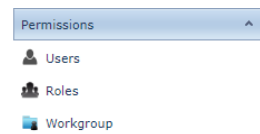

Administrator can, when creating a new user, pre-assign a layout for the offer list grid and for the offer editing grid to standardize software appearance on first launch.

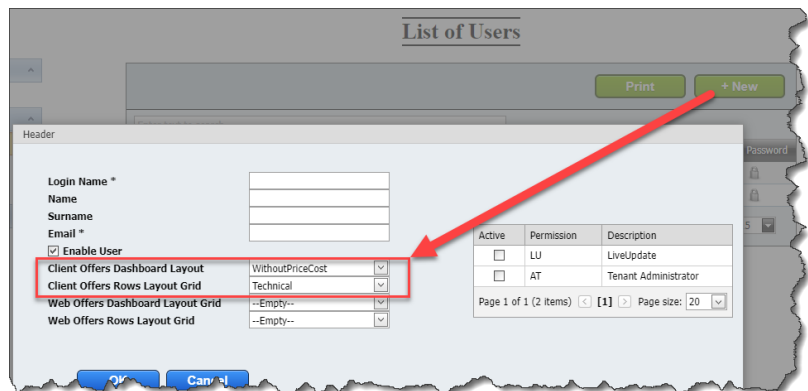

WARNING: email is sent with an Apice Consulting system account; If an "Email error" message appears or user doesn't 4.1.12 in the "Mail Settings" section, where you can proceed with an advanced configuration of sending settings.

Administrator can now customize text of the e-mail messages that are sent by the system when creating a new user or when resetting password. In both cases it is also possible for the administrator to attach a file to the e-mail, for example to attach a small introductory guide when creating a new user.



Roles

In the "Roles" section, you can create predefined permission groups. Each Role contains a set of permissions related to the various features of iQuote. Later in the workgroups section, you can assign each user a specific role.

Workgroup

Workgroup is a workgroup sharing the same database: access to same offers, same customer account, same price lists, same settings. You can create an indefinite number of workgroups; by default, there is already a workgroup called iQuote.

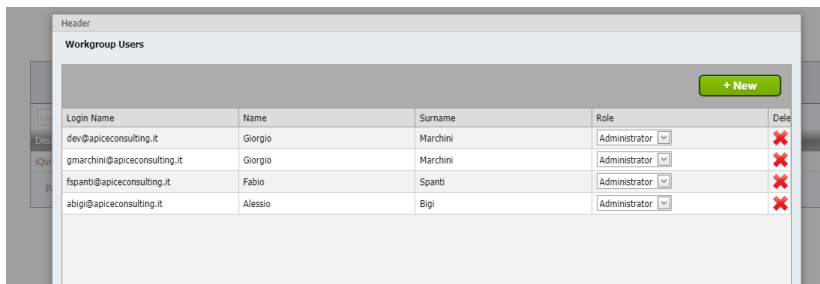

Header	Workgroup Users				
	Login Name	Name	Surname	Role	Delete
	dev@apiceconsulting.it	Giorgio	Marchini	Administrator	✗
	gmarchini@apiceconsulting.it	Giorgio	Marchini	Administrator	✗
	fgpanti@apiceconsulting.it	Fabio	Spanti	Administrator	✗
	abigi@apiceconsulting.it	Alessio	Bigi	Administrator	✗

For each Workgroup you can enter users who can be part of it and, for each of them, you can assign a specific role.

In addition, each workgroup is assigned price lists (sale/cost), so that only enabled price lists are visible in the software when creating offers.

4.1.3 Property

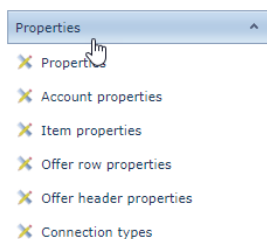

In this section you can define additional properties for the various types of objects in the software (customer/supplier account, items, offers, offer rows, connections).

First section "Properties" allows to create new properties by defining their names, values allowed, units of measure etc. You can then go to a section

dedicated to the object type, to associate created properties to the various objects (for example, in “Connection types” section, you can choose which properties to display in electrical connections, rather than gas).

4.1.4 Property - Connections symbols

A specific section allows to the administrator to introduce new connection installation symbols or hide system symbols that are never used.

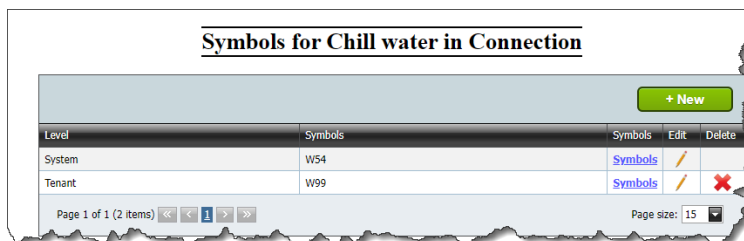

4.1.5 Settings - Currencies

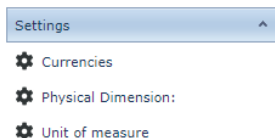

You can manage currencies on the server. All currencies in the world are already present.

In currencies menu, it is possible to update the exchange rate of a currency referring to a default currency, which will bring the reference value equal to 1 to the "Unit ratio" field.

The exchange rates can be changed at any time within the iQuoteWin application in the "Price Lists" section of the "Offer Management" (look at paragraph 1.4.3)

4.1.6 Settings – Sizes, Units of Measure

It is possible to consult the available quantities and add new units of measurement that can be used within the program by setting the configuration of the units of measurement (see point 4.1.6).

4.1.7 Settings - Unit of Measure Configuration

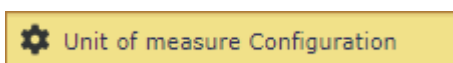

In the Unit of Measure Configuration section, the administrator can create alternative configurations to the standard ones provided within iQuote Pro. The configurations marked as “System” cannot be modified or deleted, but can be used as a starting template for a new configuration. The configurations marked as “Tenant” will be editable at will by the iQuote server administrator.

An empty configuration can be created by pressing the “New” button.

Once the configuration modification screen is opened, we are shown a grid containing the properties, the measurement units and two commands, modify and clean.

If you have chosen to use an existing configuration, the “Unit of Measure” column will be filled in, otherwise it will be empty.

The “Edit” command allows you to enter or change the unit of measurement on the line; the drop-down menu in the selection window only shows the units of measurement belonging to the same size group (length, weight, volume, etc.).

For length-type units of measurements, it is also possible to set the visibility as “fractional”, which is mainly useful for imperial units of measurement.

For all units of measurement it is possible to decide whether to force the formatting of the decimals according to the settings in iQuoteWin (see point 1.9).

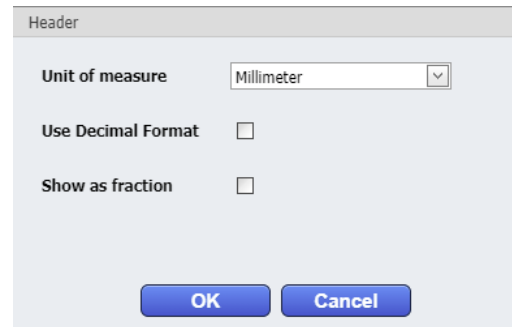

4.1.8 Settings – Conditions

Conditions

In "Conditions" section it is possible to manage sale terms, additional conditions and ancillary costs. Some of these informations are provided by default by iQuote and cannot be modified, except for the possibility to enable the display of a specific condition.

Informations	Description
Values	Power supply
Values	Delivery
Values	Consultant
Values	Additional costs
Values	Offer state description
Values	Warranty
Values	Packing

The various information are divided by category; next to each category there is the "Values" button, allowing to look at all informations available for the selected category. As already written, within the various categories there are some default values that it's not possible to delete or to modify their description in the various languages present in the program. It is however possible to add new information for the single category pressing the "+ New" button; this information is totally editable.

The management of the visibility of the individual information and the modification of the same depends on the access method of the administrator: Tenant Administrator or Workgroup Administrator. In case of access as a Tenant Administrator, the

Values for: Warranty

Level	Visible	Internal Name	Linked Element	Description	Edit	Delete
System	True	los precios incluyen un descuento en lugar de la garantía				
System	True	ver carta de presentación				
System	True	proporcionado por el Distribuidor local				
System	True	en acuerdo aparte				
Tenant	True	?? months.		Description		✖
System	True	12 months				
Tenant	True	12 months from accepted consignment		Description		✖
System	True	24 months				
Tenant	True	24 months from accepted consignment		Description		✖
System	True	36 months				
Tenant	True	36 months from accepted consignment		Description		✖
System	True	12 mesi su manodopera, 24 mesi sui ricambi				

administrator can decide to create and / or make the information visible to all the workgroups entrusted to him; information created at this level are editable and can only be deleted by the

Tenant Administrator. In case of access as a Workgroup Administrator, however, information created are visible only within the workgroup (Tenant Administrator is not able to look at or modify them), but is able to decide whether to make visible within the workgroup the information made available from the system and the Tenant Administrator.

Together with the standard categories it is possible to create customized categories, to which the information with the suffix "Label" refers, which become the categories for the "Customized" information.

4.1.9 Settings – General Options

In this section general options are present, some essential for software functionality, others that can change its behavior.

In detail:

- **Library Path:** This is the physical path where library files, work data, attachments are stored.

Normally this path is defined during installation phase. For this reason, it is recommended not to change this option, as the program may stop working and some data may be lost. If you are not sure, contact Apice Consulting technical assistance.

- **Alternative Library Path:** set an alternate library location.
- **Using Alternative Library Path:** determines whether the alternate location should be used and whether it should be considered as primary or secondary.

Library Path:	<input type="text"/>
Default Currency:	EUR <input type="button" value="v"/>
Free Prices:	<input type="checkbox"/>
Accessories extra q.ty:	<input type="checkbox"/>
Link code/model to lists:	<input checked="" type="checkbox"/>
Item Default Position:	<input type="text" value="00"/>
Active Rows Additions:	<input type="checkbox"/>
Search in pricelist	<input checked="" type="checkbox"/>
Full Text Index in searches	<input type="checkbox"/>
Dashboard Page Dimension (0 = no limit)	<input type="text" value="50"/>
Enable Job Server	<input type="checkbox"/>
Auto Enabling Pricelists to Workgroup	<input checked="" type="checkbox"/>
Attachments file size limit (0 for no limit)	<input type="text" value="0"/> Mb
Custom size limit (0 for no limit)	<input type="text" value="0"/> Mb
Database Reindex	<input type="button" value="Launch reindex"/> <input type="button" value="Check reindex state"/>

- **Calculation type:** allows administrator to select which types of calculations to display within iQuote. Values are 4: List Price (Standard), List Price (Inverse), Cost Price (Standard), Cost Price (Inverse). For use look at point (see point 1.5.10)1.5.11

<input type="checkbox"/> Select All
<input type="checkbox"/> Sell Pricelist (Standard)
<input type="checkbox"/> Sell Pricelist (Inverse)
<input type="checkbox"/> Cost Pricelist (Standard)
<input type="checkbox"/> Cost Pricelist (Inverse)

- **Default Currency:** This is the default currency used by the software to create new offers. However, this setting is non-binding and can be changed at both individual user and individual offer level.
- **Free Prices:** Enabling this option you have the possibility to freely change list prices. This change is intended only when inserting an item or on a subsequent modification of the inserted item and have value only for that instance; that is, it should not be understood as a change to the default value of the list price, that remains unchanged.
- **Accessories extra q.ty:** unties the quantity of an accessory from the parent item. Consider, for example, the insertion of a table with quantity "2" with a shelf with quantity "1". By default (i.e., with this option disabled) the offer has a total of 2 tables with 2 shelves (i.e., one shelf for each table); activating this option it is possible to change the total to 2 tables with 1 shelf (one of the two tables, therefore, is sold without the shelf).
- **Link code/model to lists:** If active, any change to code or model of an item on offer still keeps item linked to library, and therefore you can continue to take advantage of the item's synchronization commands. If it is disabled, changing code or model causes item to become a custom item and no longer related to price list.
- **Item Default Position:** Assigns a default position immediately after an item is placed in the offer/drawing (for example 00). This option must be filled in if you want to display the attribute when placing an item in iQuoteCAD or in iQuoteRevit: if this option is disabled, a CAD or Revit block doesn't display the attribute until position is assigned.
- **Active rows addition:** Enabling this option t's possible to set a series of prefixes/suffixes in the table, that are added to item's code or model when it changes status (for example, it becomes Special, Optional, Existing, ...)

Type	Prefix	Suffix	Code/Model
Special Item	<input type="text"/>	/S	Both
Optional Item	<input type="text"/>	<input type="text"/>	Code
Optional Special Item	<input type="text"/>	/S	Both
Alternative	<input type="text"/>	<input type="text"/>	Code
Alternative Special Item	<input type="text"/>	/S	Both
Existing Item	<input type="text"/>	/E	Both
Special Accessory	<input type="text"/>	/S	Both
Optional Accessory	<input type="text"/>	<input type="text"/>	Code
Optional Special Accessory	<input type="text"/>	/S	Both
Alternative Accessory	<input type="text"/>	<input type="text"/>	Code
Special Alternative Accessory	<input type="text"/>	/S	Both
Existing Accessory	<input type="text"/>	/E	Both

- **Search in pricelist:** if enabled, searches a user can do in the library are carried out within active price list, even if items are not visible in the branch navigation. Differently, if option is disabled, only items displayed in navigation are searched.
- **Full Text Index in searches:** Enabling this parameter, library searches for description words are faster; on the other hand, this option activates an indexing service, taking up more of the memory used by the database on the server.
- **Dashboard page size:** allows to the administrator to set the number of offers loaded at the same time by the iQuoteWin, if 0 (zero) all offers on the server will be loaded.
- **Enable Job Server:** This is a system setting to enable job queue management; we do not recommend to change this option if you have not previously been directed by Apice Consulting Technical Support.
- **Auto Enabling Pricelists to Workgroup:** If enabled, automatically enable new lists downloaded by liveupdate to all workgroups on the server. Otherwise, it would be necessary every time to enable them manually as shown in paragraph 4.1.2.
- **Maximum attachment size:** allows the administrator to limit the maximum size of the attachments of an offer, with the exception of project files (CAD and Revit).
- **Maximum custom file size:** allows the administrator to limit the maximum size of the file uploaded by a user, excluding the attachments of an offer.
- **Database Reindex:** Allows to start process to reindex database; we recommend you start procedure only if you were previously directed by Apice Consulting Technical Support.

4.1.10 Settings – Languages Management

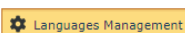

In this section, you can select the languages you want to use in the software. In particular, this setting affects datasheets and item descriptions. It is important to select only the languages actually used, to reduce libraries live-update time, in fact datasheets of selected languages only are downloaded and updated, allowing to reduce download and update time.

Moreover, more important, it's also the reduction of the space occupied by the database, as by default the iQuote server is licensed by Microsoft SQL Express version (free up to the 10Gb database size limit). After the maximum database size quota has been exceeded, it stops working and therefore iQuote stops too, until a higher version of Microsoft SQL is purchased/installed.

4.1.11 Settings – Proxy Options

Proxy Options

The "Proxy Options" section is required if your corporate network uses a proxy server to connect to the Internet. If in doubt, leave all options turned off or enable only "Use Proxy" and "Get Information from IE" entries: in this case, the Internet Explorer settings used for normal web browsing are used.

4.1.12 Settings – Mail Settings

Mail Settings

In the "Mail Settings" setting, you configure your SMTP server to send system emails, such as email to set the user password. These settings can be set as for your email client; if you are unsure, contact your e-mail administrator.

4.1.13 Settings – iQuote Account

iQuote Account

"iQuote account" is an account provided by Apice Consulting during the license purchase: this account is essential to have access to the software and iQuote Liveupdate, from which product libraries and their price lists are downloaded and initialized.

4.1.14 Settings – FTP Account

FTP Account

In this section you can configure user and password to access library using FTP protocol. We do not recommend you change this option if you have not previously been directed by Apice Consulting Technical Support.

4.1.15 Setting – Jobs

This section is present only if enabled in general options, this is the list of jobs server must perform or have already run. We do not recommend you intervene in this section if you have not previously been directed by Apice Consulting Technical Support.

4.2 DIM

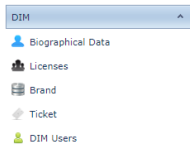

Data Integrated Management (DIM) area allows the management of your iQuote Account (look at paragraph 4.1.13). You can access this area from the administration site of your server or independently from the web by accessing the iQuote service site at <http://service.iquotepro.net> and selecting the DIM entry from the sidebar.

4.2.1 Biographical Data

Allows the read-only view of your accounting data in Apice Consulting databases.

4.2.2 Licenses

Allows to view a summary of your license status. A grid shows the list of licenses purchased or received in demo mode. For



Serial Number	Hardware Key	License Type	Modules	State	Deadline	Notes
Yes			Win, AutoCAD App, AutoCAD ODM, Revit	Active	09/12/2117	
Yes			Win, AutoCAD App, AutoCAD ODM, Revit	Active	09/12/2117	

each license, you can look at the serial number that, depending on the status of the "Hardware Key" column, may match the serial number of a hardware key or the temporary serial number provided in case of a demonstration license or temporary software license, while waiting for the hardware key to be shipped. The expiration date and modules associated with the license are then visible. By pressing the pencil icon, you can customize a note about license, such as specifying the name of the person to whom that license is intended.

4.2.3 Brand

Within this section it is possible to make requests to obtain the libraries of the Manufacturers, who have decided to publish



Description	State	Request
	Requestable	Request
	Requestable	Request
	Requestable	Request

their data on the iQuote Pro platform. A grid appears with the list of libraries available within iQuote. Apice Consulting enters into agreements with Manufacturers such that the authorization to use the library remains in the care of the Manufacturer itself, who, in total freedom, may decide to authorize its use (deciding whether to assign a sale/cost price list or not) or reject the request.

At this stage Apice Consulting cannot intervene under any circumstances. At the time of the request, an email is sent to the area manager for the brand, who decides timing and ways of intervention. Once the Manufacturer has made the decision, you are notified by email of the outcome of the

decision. If positive, you can start the iQuote Liveupdate software, in order to download the new available library.

4.2.4 Ticket

In this section you can open support tickets, if you have problems with the software. Open a ticket for each request you want to make: each ticket allows you to specify product on which you require support, type, priority, subject and message. You can also attach files to the request.

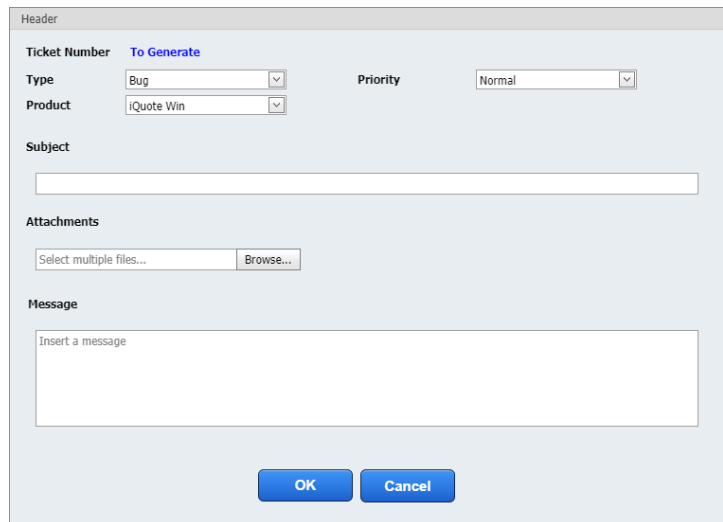

Each ticket generated has an identification number: you can use this code to call technical support at the number +39 0376 221584 choosing desired language option and then option 1 for support on iQuote. You are then prompted to enter ticket code. Depending on technician workload, the driving voice may ask you to leave a voice message, so you will be contacted again as soon as the first technician is available.

4.2.5 DIM users

This section allows administrator to create additional DIM users than the primary one provided to you when purchasing the software. These additional users have limited rights to the primary user, for example, they are not able to view licensing section or request new libraries. Main use of these users is for support tickets creation.

5 IQUOTE LIVEUPDATE

5.1 IQUOTE LIVEUPDATE

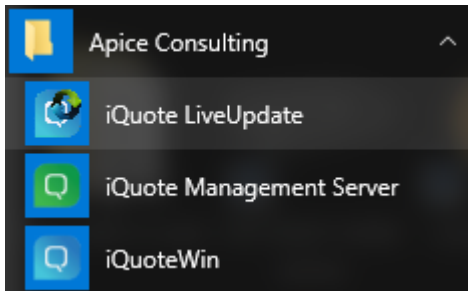

iQuote Liveupdate allows you to keep all the software up to date, both for the SOFTWARE (iQuoteWin, iQuoteCAD, iQuoteManagement, etc.) and for data (account, price lists, library files, etc.).

iQuote LiveUpdate can be reached, like other applications, from the Start->Programs->Apice Consulting menu; it should also be noted that iQuote installation setup creates a boots-start system service, called iQuoteService, which handles the automatic execution of the process when Windows starts. Once you reach the Windows desktop, you can view the status icon in the notification bar, next to your system clock. Service then works in background, checking for available updates at predefined intervals.

Notification icon already lets you know if new updates are available or not:



The standard icon, appearing here on the left, indicates service is running but no new updates are available. Installation is then successfully updated.



The yellow star icon, on the other hand, indicates there are new updates not yet downloaded and/or installed by the user. In addition to this icon, a notification initially appears indicating there are new updates to download/install.

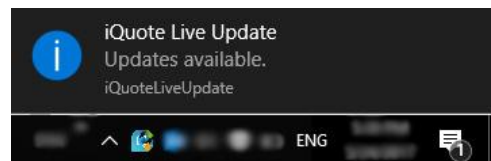

5.2 INTERFACE

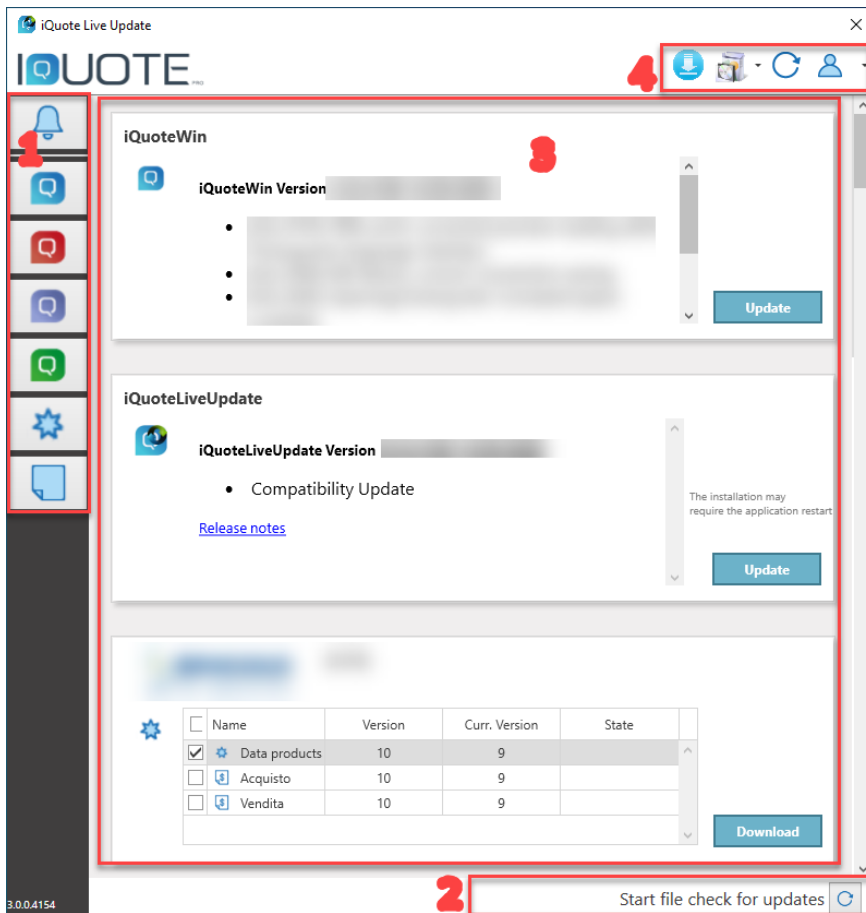

iQuote Liveupdate window consists of 4 sections:

1. **FILTERS:** You can filter the view of available updates from respective icon:
 - All available updates
 - QuoteWin (client; project/offer management)
 - iQuoteCAD (client; drawing manager)
 - iQuoteRevit (client; drawing manager)
 - iQuoteBackoffice (server; database/web server and related services)
 - Brand (server, account database, price lists)
 - Files (images/DWG/item datasheets)
2. **FILE SEARCH:** the file search process (images/DWG/technical data sheets of the articles), can be performed in two way: a light one, faster and performed automatically when iQuote Liveupdate is started (the search is done by verifying the existence of the file and any date);

the second, more time-consuming, can be performed at the user's request or automatically by enabling the option in the iQuote Liveupdate preferences (see point 5.5). The full search, being more expensive, runs in the background, so you can perform the other iQuote Liveupdate tasks. In this section you can view the status.

N.B.

The complete check, although more complex, allows the software to detect any corrupt files that would not be detected in the light check.

3. **UPDATES:** This is the main section, listing available updates (based on the filters you selected as shown in step 1 above). For each update you can view a detailed list of what's new in the version.
4. **MANAGER:** for each icon functionality activated is respectively:
 - You can download all possible;
 - install all updates with a single click;
 - a new scan of available updates;
 - current user logout from live update; close live update or access options.

5.3 UPDATE WIN/CAD/BACKOFFICE/BRAND

The update of software (iQuoteWin, iQuoteRevit, iQuoteCAD, iQuoteBackoffice and iQuote Liveupdate) takes two steps:

1. **DOWNLOAD** (for iQuote server administrator users only): the software is downloaded and saved on the server, so that is available to all connected users; you can download more softwares: the software you decide to download is paced in a queue managed directly by iQuote Liveupdate.
2. **UPDATE** (for all users): iQuote Liveupdate checks the status of user installations, showing only the software that is currently installed on the machine. It is possible to queue more updates, the queue will then be managed automatically by iQuote Liveupdate.

N.B.

To properly update the software, it is necessary to close the application being updated, otherwise iQuote Liveupdate asks the user to close the application and then retry the update.

iQuote Liveupdate closes automatically when the update is launched.

As for the data update, visible only for the administrator of the iQuote server, the update takes place in a single phase: only the “UPDATE” button is shown; this allows you to add the chosen brand to the queue, the queue is managed independently by iQuote Liveupdate.

5.4 UPDATE FILE

File updates take place, unlike previous ones, with a single click: once files are selected, the "Download" button is activated, starting downloading process and installing updated files.

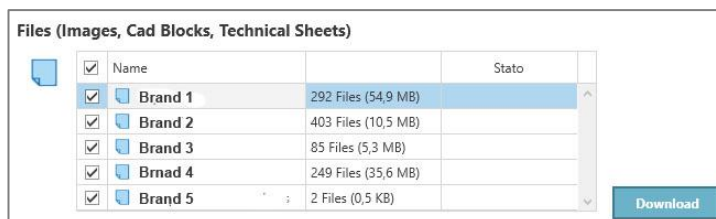

5.5 OPTIONS

By accessing the iQuote Liveupdate options, you can set which software and for which brands you want to receive updates for. You can also enable or disable automatic file checking (pdf, dwg, jpg) when iQuote Liveupdate starts.

